

573

PILOT'S OPERATING HANDBOOK

 Cessna® 1976

**Skyhawk**  
CESSNA MODEL 172M



PILOT'S OPERATING HANDBOOK

Cessna® 1976

Skyhawk

CESSNA MODEL 172.M

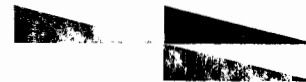

PERFORMANCE-  
SPECIFICATIONS

CESSNA  
MODEL 172M

PERFORMANCE - SPECIFICATIONS

SPEED:

Maximum at Sea Level . . . . . 125 KNOTS  
Cruise, 75% Power at 8000 Ft . . . . . 120 KNOTS

CRUISE: Recommended Lean Mixture with fuel allowance for engine start, taxi, takeoff, climb and 45 minutes reserve at 45% power.

75% Power at 8000 Ft . . . . .	Range	450 NM
38 Gallons Usable Fuel . . . . .	Time	3.9 HRS
75% Power at 8000 Ft . . . . .	Range	595 NM
48 Gallons Usable Fuel . . . . .	Time	5.1 HRS
Maximum Range at 10,000 Ft . . . . .	Range	480 NM
38 Gallons Usable Fuel . . . . .	Time	4.8 HRS
Maximum Range at 10,000 Ft . . . . .	Range	640 NM
48 Gallons Usable Fuel . . . . .	Time	6.3 HRS

RATE OF CLIMB AT SEA LEVEL . . . . . 645 FPM  
SERVICE CEILING . . . . . 13,100 FT

TAKEOFF PERFORMANCE:

Ground Roll . . . . . 865 FT  
Total Distance Over 50-Ft Obstacle . . . . . 1525 FT

LANDING PERFORMANCE:

Ground Roll . . . . . 520 FT  
Total Distance Over 50-Ft Obstacle . . . . . 1250 FT

STALL SPEED (CAS):

Flaps Up, Power Off . . . . . 50 KNOTS  
Flaps Down, Power Off . . . . . 44 KNOTS

MAXIMUM WEIGHT . . . . . 2300 LBS

STANDARD EMPTY WEIGHT:

Skyhawk . . . . . 1387 LBS  
Skyhawk II . . . . . 1412 LBS

MAXIMUM USEFUL LOAD:

Skyhawk . . . . . 913 LBS  
Skyhawk II . . . . . 888 LBS

BAGGAGE ALLOWANCE . . . . . 120 LBS

WING LOADING: Pounds/Sq Ft . . . . . 13.2

POWER LOADING: Pounds/HP . . . . . 15.3

FUEL CAPACITY: Total

Standard Tanks . . . . . 42 GAL.  
Long Range Tanks . . . . . 52 GAL.

OIL CAPACITY . . . . . 8 QTS

ENGINE: Avco Lycoming . . . . . O-320-E2D  
150 BHP at 2700 RPM

PROPELLER: Fixed Pitch, Diameter . . . . . 75 IN.

PILOT'S OPERATING HANDBOOK

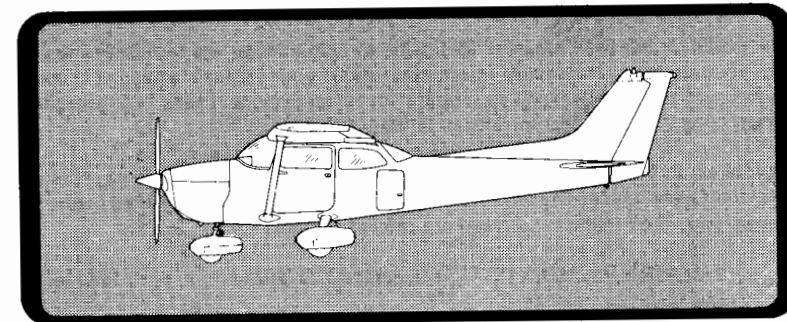

SKYHAWK

1976 MODEL 172M

Serial No. \_\_\_\_\_

Registration No. \_\_\_\_\_

THIS HANDBOOK INCLUDES THE MATERIAL  
REQUIRED TO BE FURNISHED TO THE PILOT  
BY CAR PART 3

CESSNA AIRCRAFT COMPANY  
WICHITA, KANSAS, USA

# CONGRATULATIONS . . . .

Welcome to the ranks of Cessna owners! Your Cessna has been designed and constructed to give you the most in performance, economy, and comfort. It is our desire that you will find flying it, either for business or pleasure, a pleasant and profitable experience.

This handbook has been prepared as a guide to help you get the most pleasure and utility from your airplane. It contains information about your Cessna's equipment, operating procedures, and performance; and suggestions for its servicing and care. We urge you to read it from cover to cover, and to refer to it frequently.

Our interest in your flying pleasure has not ceased with your purchase of a Cessna. World-wide, the Cessna Dealer Organization backed by the Cessna Service Department stands ready to serve you. The following services are offered by most Cessna Dealers:

**THE CESSNA WARRANTY** -- It is designed to provide you with the most comprehensive coverage possible:

- a. No exclusions
- b. Coverage includes parts and labor
- c. Available at Cessna Dealers world wide
- d. Best in the industry

Specific benefits and provisions of the warranty plus other important benefits for you are contained in your Customer Care Program book supplied with your airplane. Warranty service is available to you at any authorized Cessna Dealer throughout the world upon presentation of your Customer Care Card which establishes your eligibility under the warranty.

**FACTORY TRAINED PERSONNEL** to provide you with courteous expert service.

**FACTORY APPROVED SERVICE EQUIPMENT** to provide you with the most efficient and accurate workmanship possible.

**A STOCK OF GENUINE CESSNA SERVICE PARTS** on hand when you need them.

**THE LATEST AUTHORITATIVE INFORMATION FOR SERVICING CESSNA AIRPLANES**, since Cessna Dealers have all of the Service Manuals and Parts Catalogs, kept current by Service Letters and Service News Letters, published by Cessna Aircraft Company.

We urge all Cessna owners to use the Cessna Dealer Organization to the fullest.

A current Cessna Dealer Directory accompanies your new airplane. The Directory is revised frequently, and a current copy can be obtained from your Cessna Dealer. Make your Directory one of your cross-country flight planning aids; a warm welcome awaits you at every Cessna Dealer.

# TABLE OF CONTENTS

	SECTION
GENERAL . . . . .	1
LIMITATIONS . . . . .	2
EMERGENCY PROCEDURES . . . . .	3
NORMAL PROCEDURES . . . . .	4
PERFORMANCE . . . . .	5
WEIGHT & BALANCE/ EQUIPMENT LIST . . . . .	6
AIRPLANE & SYSTEMS DESCRIPTIONS . . . . .	7
AIRPLANE HANDLING, SERVICE & MAINTENANCE . . . . .	8
SUPPLEMENTS (Optional Systems Description & Operating Procedures) . . . . .	9

---

This handbook will be kept current by Service Letters published by Cessna Aircraft Company. These are distributed to Cessna Dealers and to those who subscribe through the Owner Follow-Up System. If you are not receiving subscription service, you will want to keep in touch with your Cessna Dealer for information concerning the change status of the handbook. Subsequent changes will be made in the form of stickers. These should be examined and attached to the appropriate page in the handbook immediately after receipt; the handbook should not be used for operational purposes until it has been updated to a current status.

---

# SECTION 1 GENERAL

## TABLE OF CONTENTS

	Page
Three View . . . . .	1-2
Introduction . . . . .	1-3
Descriptive Data . . . . .	1-3
Engine . . . . .	1-3
Propeller . . . . .	1-3
Fuel . . . . .	1-3
Oil . . . . .	1-4
Maximum Certificated Weights . . . . .	1-5
Standard Airplane Weights . . . . .	1-5
Cabin and Entry Dimensions . . . . .	1-5
Baggage Space and Entry Dimensions . . . . .	1-5
Specific Loadings . . . . .	1-5
Symbols, Abbreviations and Terminology . . . . .	1-6
General Airspeed Terminology and Symbols . . . . .	1-6
Meteorological Terminology . . . . .	1-6
Engine Power Terminology . . . . .	1-7
Airplane Performance and Flight Planning Terminology . . . . .	1-7
Weight and Balance Terminology . . . . .	1-7

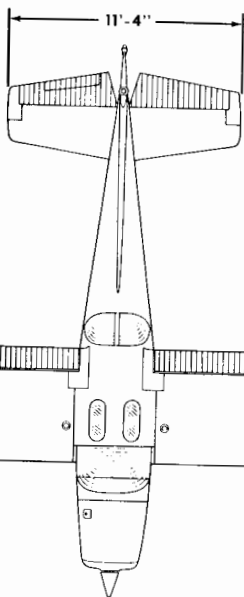
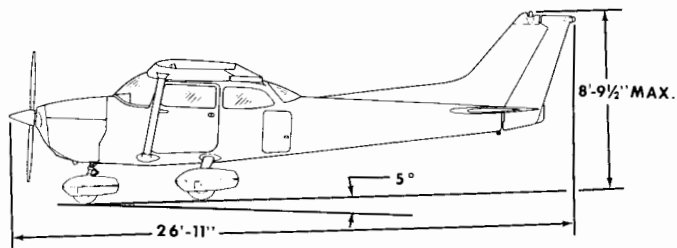

NOTES:

1. Wing span shown with strobe lights installed.
2. Maximum height shown with nose gear depressed, all tires and nose strut properly inflated, and flashing beacon installed.
3. Wheel base length is 65".
4. Propeller ground clearance is 11 3/4".
5. Wing area is 174 square feet.
6. Minimum turning radius (\*pivot point to outboard wing tip) is 27' 5 1/2".

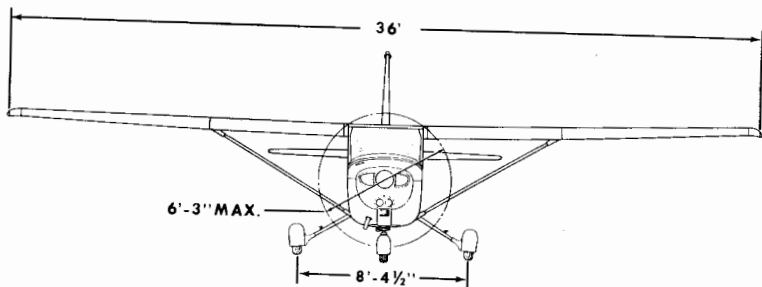

Figure 1-1. Three View

## INTRODUCTION

This handbook contains 9 sections, and includes the material required to be furnished to the pilot by CAR Part 3. It also contains supplemental data supplied by Cessna Aircraft Company.

Section 1 provides basic data and information of general interest. It also contains definitions or explanations of symbols, abbreviations, and terminology commonly used.

## DESCRIPTIVE DATA

### ENGINE

Number of Engines: 1.

Engine Manufacturer: Avco Lycoming.

Engine Model Number: O-320-E2D.

Engine Type: Normally-aspirated, direct-drive, air-cooled, horizontally-opposed, carburetor equipped, four-cylinder engine with 320 cu. in. displacement.

Horsepower Rating and Engine Speed: 150 rated BHP at 2700 RPM.

### PROPELLER

Propeller Manufacturer: McCauley Accessory Division.

Propeller Model Number: 1C160/DTM7553.

Number of Blades: 2.

Propeller Diameter, Maximum: 75 inches.

Minimum: 74 inches.

Propeller Type: Fixed pitch.

### FUEL

Fuel Grade (and Color): 80/87 Minimum Grade Aviation Fuel (red).

Alternate fuels which are also approved are:

100/130 Low Lead AVGAS (green). (Maximum lead content of 2 cc per gallon.)

100/130 Aviation Grade Fuel (green). (Maximum lead content of 4.6 cc per gallon.)

### NOTE

When substituting a higher octane fuel, low lead AVGAS 100 should be used whenever possible since it will result in less lead contamination of the engine.

Fuel Capacity:

Standard Tanks:

Total Capacity: 42 gallons.

Total Capacity Each Tank: 21 gallons.

Total Usable: 38 gallons.

Long Range Tanks:

Total Capacity: 52 gallons.

Total Capacity Each Tank: 26 gallons.

Total Usable: 48 gallons.

NOTE

To ensure maximum fuel capacity when refueling, place the fuel selector valve in either LEFT or RIGHT position to prevent cross-feeding.

OIL

Oil Grade (Specification):

MIL-L-6082 Aviation Grade Straight Mineral Oil: Use to replenish supply during first 25 hours and at the first 25-hour oil change. Continue to use until a total of 50 hours has accumulated or oil consumption has stabilized.

NOTE

The airplane was delivered from the factory with a corrosion preventive aircraft engine oil. This oil should be drained after the first 25 hours of operation.

MIL-L-22851 Ashless Dispersant Oil: This oil must be used after first 50 hours or oil consumption has stabilized.

Recommended Viscosity For Temperature Range:

SAE 50 above 16°C (60°F).

SAE 10W30 or SAE 30 between -18°C (0°F) and 21°C (70°F).

SAE 10W30 or SAE 20 below -12°C (10°F).

NOTE

Multi-viscosity oil with a range of SAE 10W30 is recommended for improved starting in cold weather.

Oil Capacity:

Sump: 8 Quarts.

Total: 9 Quarts.

MAXIMUM CERTIFICATED WEIGHTS

Takeoff, Normal Category: 2300 lbs.

Utility Category: 2000 lbs.

Landing, Normal Category: 2300 lbs.

Utility Category: 2000 lbs.

Weight in Baggage Compartment, Normal Category:

Baggage Area 1 (or passenger on child's seat)-Station 82 to 108:  
120 lbs. See note below.

Baggage Area 2 -Station 108 to 142: 50 lbs. See note below.

NOTE

The maximum combined weight capacity for baggage areas 1 and 2 is 120 lbs.

Weight in Baggage Compartment, Utility Category: In this category, the baggage compartment and rear seat must not be occupied.

STANDARD AIRPLANE WEIGHTS

Standard Empty Weight, Skyhawk: 1387 lbs.

Skyhawk II: 1412 lbs.

Maximum Useful Load:

	<u>Normal Category</u>	<u>Utility Category</u>
Skyhawk:	913 lbs.	613 lbs.
Skyhawk II:	888 lbs.	588 lbs.

CABIN AND ENTRY DIMENSIONS

Detailed dimensions of the cabin interior and entry door openings are illustrated in Section 6.

BAGGAGE SPACE AND ENTRY DIMENSIONS

Dimensions of the baggage area and baggage door opening are illustrated in detail in Section 6.

SPECIFIC LOADINGS

Wing Loading: 13.2 lbs./sq. ft.

Power Loading: 15.3 lbs./hp.

**SYMBOLS, ABBREVIATIONS AND TERMINOLOGY****GENERAL AIRSPEED TERMINOLOGY AND SYMBOLS**

KCAS	<u>Knots Calibrated Airspeed</u> is indicated airspeed corrected for position and instrument error and expressed in knots. Knots calibrated airspeed is equal to KTAS in standard atmosphere at sea level.
KIAS	<u>Knots Indicated Airspeed</u> is the speed shown on the airspeed indicator and expressed in knots.
KTAS	<u>Knots True Airspeed</u> is the airspeed expressed in knots relative to undisturbed air which is KCAS corrected for altitude and temperature.
V <sub>A</sub>	<u>Maneuvering Speed</u> is the maximum speed at which you may use abrupt control travel.
V <sub>FE</sub>	<u>Maximum Flap Extended Speed</u> is the highest speed permissible with wing flaps in a prescribed extended position.
V <sub>NO</sub>	<u>Maximum Structural Cruising Speed</u> is the speed that should not be exceeded except in smooth air, then only with caution.
V <sub>NE</sub>	<u>Never Exceed Speed</u> is the speed limit that may not be exceeded at any time.
V <sub>S</sub>	<u>Stalling Speed or the minimum steady flight speed</u> at which the airplane is controllable.
V <sub>S<sub>0</sub></sub>	<u>Stalling Speed or the minimum steady flight speed</u> at which the airplane is controllable in the landing configuration at the most forward center of gravity.
V <sub>X</sub>	<u>Best Angle-of-Climb Speed</u> is the speed which results in the greatest gain of altitude in a given horizontal distance.
V <sub>Y</sub>	<u>Best Rate-of-Climb Speed</u> is the speed which results in the greatest gain in altitude in a given time.

**METEOROLOGICAL TERMINOLOGY**

OAT	<u>Outside Air Temperature</u> is the free air static temperature. It is expressed in either degrees Celsius (formerly Centigrade) or degrees Fahrenheit.
-----	---

Standard Temperature	<u>Standard Temperature</u> is 15°C at sea level pressure altitude and decreases by 2°C for each 1000 feet of altitude.
Pressure Altitude	<u>Pressure Altitude</u> is the altitude read from an altimeter when the barometric subscale has been set to 29.92 inches of mercury (1013 mb).

**ENGINE POWER TERMINOLOGY**

BHP	<u>Brake Horsepower</u> is the power developed by the engine.
RPM	<u>Revolutions Per Minute</u> is engine speed.
Static RPM	<u>Static RPM</u> is engine speed attained during a full-throttle engine runup when the airplane is on the ground and stationary.

**AIRPLANE PERFORMANCE AND FLIGHT PLANNING TERMINOLOGY**

Demonstrated Crosswind Velocity	<u>Demonstrated Crosswind Velocity</u> is the velocity of the crosswind component for which adequate control of the airplane during takeoff and landing was actually demonstrated during certification tests. The value shown is not considered to be limiting.
Usable Fuel	<u>Usable Fuel</u> is the fuel available for flight planning.
Unusable Fuel	<u>Unusable Fuel</u> is the quantity of fuel that can not be safely used in flight.
GPH	<u>Gallons Per Hour</u> is the amount of fuel (in gallons) consumed per hour.
NMPG	<u>Nautical Miles Per Gallon</u> is the distance (in nautical miles) which can be expected per gallon of fuel consumed at a specific engine power setting and/or flight configuration.
g	g is acceleration due to gravity.

**WEIGHT AND BALANCE TERMINOLOGY**

Reference Datum	<u>Reference Datum</u> is an imaginary vertical plane from which all horizontal distances are measured for balance purposes.
Station	<u>Station</u> is a location along the airplane fuselage given in terms of the distance from the reference datum.



Arm	<u>Arm</u> is the horizontal distance from the reference datum to the center of gravity (C.G.) of an item.
Moment	<u>Moment</u> is the product of the weight of an item multiplied by its arm. (Moment divided by the constant 1000 is used in this handbook to simplify balance calculations by reducing the number of digits.)
Center of Gravity (C.G.)	<u>Center of Gravity</u> is the point at which an airplane, or equipment, would balance if suspended. Its distance from the reference datum is found by dividing the total moment by the total weight of the airplane.
C. G. Arm	<u>Center of Gravity Arm</u> is the arm obtained by adding the airplane's individual moments and dividing the sum by the total weight.
C. G. Limits	<u>Center of Gravity Limits</u> are the extreme center of gravity locations within which the airplane must be operated at a given weight.
Standard Empty Weight	<u>Standard Empty Weight</u> is the weight of a standard airplane, including unusable fuel, full operating fluids and full engine oil.
Basic Empty Weight	<u>Basic Empty Weight</u> is the standard empty weight plus the weight of optional equipment.
Useful Load	<u>Useful Load</u> is the difference between takeoff weight and the basic empty weight.
Gross (Loaded) Weight	<u>Gross (Loaded) Weight</u> is the loaded weight of the airplane.
Maximum Takeoff Weight	<u>Maximum Takeoff Weight</u> is the maximum weight approved for the start of the takeoff run.
Maximum Landing Weight	<u>Maximum Landing Weight</u> is the maximum weight approved for the landing touchdown.
Tare	<u>Tare</u> is the weight of chocks, blocks, stands, etc. used when weighing an airplane, and is included in the scale readings. Tare is deducted from the scale reading to obtain the actual (net) airplane weight.

# SECTION 2 LIMITATIONS

## TABLE OF CONTENTS

	Page
Introduction . . . . .	2-3
Airspeed Limitations . . . . .	2-4
Airspeed Indicator Markings . . . . .	2-5
Power Plant Limitations . . . . .	2-5
Power Plant Instrument Markings . . . . .	2-6
Weight Limits . . . . .	2-6
Normal Category . . . . .	2-6
Utility Category . . . . .	2-7
Center of Gravity Limits . . . . .	2-7
Normal Category . . . . .	2-7
Utility Category . . . . .	2-7
Maneuver Limits . . . . .	2-7
Normal Category . . . . .	2-7
Utility Category . . . . .	2-7
Flight Load Factor Limits . . . . .	2-8
Normal Category . . . . .	2-8
Utility Category . . . . .	2-8
Kinds of Operation Limits . . . . .	2-9
Fuel Limitations . . . . .	2-9
Placards . . . . .	2-10

## INTRODUCTION

Section 2 includes operating limitations, instrument markings, and basic placards necessary for the safe operation of the airplane, its engine, standard systems and standard equipment. The limitations included in this section have been approved by the Federal Aviation Administration. When applicable, limitations associated with optional systems or equipment are included in Section 9.

### NOTE

The airspeeds listed in the Airspeed Limitations chart (figure 2-1) and the Airspeed Indicator Markings chart (figure 2-2) are based on Airspeed Calibration data shown in Section 5 with the normal static source. If the alternate static source is being used, ample margins should be observed to allow for the airspeed calibration variations between the normal and alternate static sources as shown in Section 5.

Your Cessna is certificated under FAA Type Certificate No. 3A12 as Cessna Model No. 172M.

**AIRSPED LIMITATIONS**

Airspeed limitations and their operational significance are shown in figure 2-1.

	SPEED	KCAS	KIAS	REMARKS
V <sub>NE</sub>	Never Exceed Speed	158	160	Do not exceed this speed in any operation.
V <sub>NO</sub>	Maximum Structural Cruising Speed	126	128	Do not exceed this speed except in smooth air, and then only with caution.
V <sub>A</sub>	Maneuvering Speed: 2300 Pounds 1950 Pounds 1600 Pounds	96 88 80	97 89 80	Do not make full or abrupt control movements above this speed.
V <sub>FE</sub>	Maximum Flap Extended Speed	86	85	Do not exceed this speed with flaps down.
	Maximum Window Open Speed	158	160	Do not exceed this speed with windows open.

Figure 2-1. Airspeed Limitations

**AIRSPED INDICATOR MARKINGS**

Airspeed indicator markings and their color code significance are shown in figure 2-2.

MARKING	KIAS VALUE OR RANGE	SIGNIFICANCE
White Arc	41 - 85	Full Flap Operating Range. Lower limit is maximum weight V <sub>SO</sub> in landing configuration. Upper limit is maximum speed permissible with flaps extended.
Green Arc	47 - 128	Normal Operating Range. Lower limit is maximum weight V <sub>S</sub> with flaps retracted. Upper limit is maximum structural cruising speed.
Yellow Arc	128 - 160	Operations must be conducted with caution and only in smooth air.
Red Line	160	Maximum speed for all operations.

Figure 2-2. Airspeed Indicator Markings

**POWER PLANT LIMITATIONS**

Engine Manufacturer: Avco Lycoming.

Engine Model Number: O-320-E2D.

Engine Operating Limits for Takeoff and Continuous Operations:

Maximum Power: 150 BHP.

Maximum Engine Speed: 2700 RPM.

**NOTE**

The static RPM range at full throttle (carburetor heat off) is 2300 to 2420 RPM.

Maximum Oil Temperature: 118°C (245°F).

Oil Pressure, Minimum: 25 psi.

Maximum: 100 psi.

Propeller Manufacturer: McCauley Accessory Division.

Propeller Model Number: 1C160/DTM7553.

Propeller Diameter, Maximum: 75 inches.

Minimum: 74 inches.

**POWER PLANT INSTRUMENT MARKINGS**

Power plant instrument markings and their color code significance are shown in figure 2-3.

INSTRUMENT	RED LINE	GREEN ARC	YELLOW ARC	RED LINE
	MINIMUM LIMIT	NORMAL OPERATING	CAUTION RANGE	MAXIMUM LIMIT
Tachometer At Sea Level	---	2200 - 2500 RPM	---	2700 RPM
At 5000 Ft.	---	2200 - 2600 RPM	---	2700 RPM
At 10,000 Ft.	---	2200 - 2700 RPM	---	2700 RPM
Oil Temperature	---	100 <sup>o</sup> -245 <sup>o</sup> F	---	245 <sup>o</sup> F
Oil Pressure	25 psi	60-90 psi	---	100 psi
Carburetor Air Temperature	---	---	-15 <sup>o</sup> to 5 <sup>o</sup> C	---

Figure 2-3. Power Plant Instrument Markings

**WEIGHT LIMITS****NORMAL CATEGORY**

Maximum Takeoff Weight: 2300 lbs.

Maximum Landing Weight: 2300 lbs.

Maximum Weight in Baggage Compartment:

Baggage Area 1 (or passenger on child's seat)-Station 82 to 108:  
120 lbs. See note below.

Baggage Area 2 -Station 108 to 142: 50 lbs. See note below.

**NOTE**

The maximum combined weight capacity for baggage areas 1 and 2 is 120 lbs.

**UTILITY CATEGORY**

Maximum Takeoff Weight: 2000 lbs.

Maximum Landing Weight: 2000 lbs.

Maximum Weight in Baggage Compartment: In the utility category, the baggage compartment and rear seat must not be occupied.

**CENTER OF GRAVITY LIMITS****NORMAL CATEGORY**

Center of Gravity Range:

Forward: 35.0 inches aft of datum at 1950 lbs. or less, with straight line variation to 38.5 inches aft of datum at 2300 lbs.

Aft: 47.3 inches aft of datum at all weights.

Reference Datum: Front face of firewall.

**UTILITY CATEGORY**

Center of Gravity Range:

Forward: 35.0 inches aft of datum at 1950 lbs. or less, with straight line variation to 35.5 inches aft of datum at 2000 lbs.

Aft: 40.5 inches aft of datum at all weights.

Reference Datum: Front face of firewall.

**MANEUVER LIMITS****NORMAL CATEGORY**

This airplane is certificated in both the normal and utility category. The normal category is applicable to aircraft intended for non-aerobatic operations. These include any maneuvers incidental to normal flying, stalls (except whip stalls) and turns in which the angle of bank is not more than 60°.

**UTILITY CATEGORY**

This airplane is not designed for purely aerobatic flight. However, in the acquisition of various certificates such as commercial pilot, instrument pilot and flight instructor, certain maneuvers are required by the FAA. All of these maneuvers are permitted in this airplane when operated in the utility category.

In the utility category, the baggage compartment and rear seat must

not be occupied. No aerobatic maneuvers are approved except those listed below:

MANEUVER	RECOMMENDED ENTRY SPEED*
Chandelles . . . . .	105 knots
Lazy Eights . . . . .	105 knots
Steep Turns . . . . .	95 knots
Spins . . . . .	Slow Deceleration
Stalls (Except Whip Stalls). . . . .	Slow Deceleration

\*Abrupt use of the controls is prohibited above 97 knots.

Aerobatics that may impose high loads should not be attempted. The important thing to bear in mind in flight maneuvers is that the airplane is clean in aerodynamic design and will build up speed quickly with the nose down. Proper speed control is an essential requirement for execution of any maneuver, and care should always be exercised to avoid excessive speed which in turn can impose excessive loads. In the execution of all maneuvers, avoid abrupt use of controls. Intentional spins with flaps extended are prohibited.

## FLIGHT LOAD FACTOR LIMITS

### NORMAL CATEGORY

Flight Load Factors (Gross Weight - 2300 lbs.)

*Flaps Up . . . . .	+3.8g, -1.52g
*Flaps Down . . . . .	+3.0g

\*The design load factors are 150% of the above, and in all cases, the structure meets or exceeds design loads.

### UTILITY CATEGORY

Flight Load Factors (Gross Weight - 2000 lbs.)

*Flaps Up . . . . .	+4.4g, -1.76g
*Flaps Down . . . . .	+3.0g

\*The design load factors are 150% of the above, and in all cases, the structure meets or exceeds design loads.

## KINDS OF OPERATION LIMITS

The airplane is equipped for day VFR and may be equipped for night VFR and/or IFR operations. FAR Part 91 establishes the minimum required instrumentation and equipment for these operations. The reference to types of flight operations on the operating limitations placard reflects equipment installed at the time of Airworthiness Certificate issuance.

Flight into known icing conditions is prohibited.

## FUEL LIMITATIONS

- 2 Standard Tanks: 21 U.S. gallons each.  
Total Fuel: 42 U.S. gallons.  
Usable Fuel (all flight conditions): 38 U.S. gallons.  
Unusable Fuel: 4.0 U.S. gallons.
- 2 Long Range Tanks: 26 U.S. gallons each.  
Total Fuel: 52 U.S. gallons.  
Usable Fuel (all flight conditions): 48 U.S. gallons.  
Unusable Fuel: 4.0 U.S. gallons.

### NOTE

To ensure maximum fuel capacity when refueling, place the fuel selector valve in either LEFT or RIGHT position to prevent cross-feeding.

### NOTE

Takeoff and land with the fuel selector valve handle in the BOTH position.

- Fuel Grade (and Color): 80/87 Minimum Grade Aviation Fuel (red).  
Alternate fuels which are also approved are:  
100/130 Low Lead AVGAS (green). (Maximum lead content of 2 cc per gallon.)  
100/130 Aviation Grade Fuel (green). (Maximum lead content of 4.6 cc per gallon.)

### NOTE

When substituting a higher octane fuel, low lead AVGAS 100 should be used whenever possible since it will result in less lead contamination of the engine.

**PLACARDS**

The following information is displayed in the form of composite or individual placards.

(1) In full view of the pilot: (The "DAY-NIGHT-VFR-IFR" entry, shown on the example below, will vary as the airplane is equipped.)

This airplane must be operated in compliance with the operating limitations as stated in the form of placards, markings, and manuals.

—————MAXIMUMS—————

	Normal Category	Utility Category
MANEUVERING SPEED (IAS)	. . . 97 knots . . . . .	97 knots
GROSS WEIGHT	. . . . . 2300 lbs. . . . .	2000 lbs.
FLIGHT LOAD FACTOR		
Flaps Up	. . . +3.8, -1.52 . . . . .	+4.4, -1.76
Flaps Down	. . . +3.0 . . . . .	+3.0

Normal Category - No acrobatic maneuvers including spins approved.  
Utility Category - Baggage compartment and rear seat must not be occupied.

————— NO ACROBATIC MANEUVERS APPROVED —————  
EXCEPT THOSE LISTED BELOW

<u>Maneuver</u>	<u>Recm. Entry Speed</u>	<u>Maneuver</u>	<u>Recm. Entry Speed</u>
Chandelles . . . . .	105 knots	Spins . . . . .	Slow Deceleration
Lazy Eights . . . . .	105 knots	Stalls (except	
Steep Turns . . . . .	95 knots	whip stalls)	Slow Deceleration

Altitude loss in stall recovery -- 180 feet.  
Abrupt use of controls prohibited above 97 knots.  
Spin Recovery: opposite rudder - forward elevator - neutralize controls. Intentional spins with flaps extended are prohibited.  
Flight into known icing conditions prohibited. This airplane is certified for the following flight operations as of date of original airworthiness certificate:

DAY - NIGHT - VFR - IFR

(2) Forward of fuel selector valve:

BOTH TANKS ON FOR  
TAKEOFF & LANDING

(3) On the fuel selector valve (standard tanks):

BOTH - 38 GAL. ALL FLIGHT ATTITUDES  
LEFT - 19 GAL. LEVEL FLIGHT ONLY  
RIGHT - 19 GAL. LEVEL FLIGHT ONLY  
OFF

On the fuel selector valve (long range tanks):

BOTH - 48 GAL. ALL FLIGHT ATTITUDES  
LEFT - 24 GAL. LEVEL FLIGHT ONLY  
RIGHT - 24 GAL. LEVEL FLIGHT ONLY  
OFF

(4) Near fuel tank filler cap (standard tanks):

FUEL  
80/87 MIN. GRADE AVIATION GASOLINE  
CAP. 21 U. S. GAL.

Near fuel tank filler cap (long range tanks):

FUEL  
80/87 MIN. GRADE AVIATION GASOLINE  
CAP. 26 U. S. GAL.

(5) Near flap indicator:

AVOID SLIPS WITH FLAPS EXTENDED

(6) In baggage compartment:

120 POUNDS MAXIMUM  
BAGGAGE AND/OR AUXILIARY PASSENGER  
FORWARD OF BAGGAGE DOOR LATCH

50 POUNDS MAXIMUM  
BAGGAGE AFT OF BAGGAGE DOOR LATCH

MAXIMUM 120 POUNDS COMBINED

FOR ADDITIONAL LOADING INSTRUCTIONS  
SEE WEIGHT AND BALANCE DATA

(7) On the instrument panel near over-voltage light:

HIGH VOLTAGE

# SECTION 3 EMERGENCY PROCEDURES

## TABLE OF CONTENTS

	Page
Introduction . . . . .	3-3
Airspeeds For Safe Operation . . . . .	3-3
<b>OPERATIONAL CHECKLISTS</b>	
Engine Failures . . . . .	3-3
Engine Failure During Takeoff Run . . . . .	3-3
Engine Failure Immediately After Takeoff . . . . .	3-3
Engine Failure During Flight . . . . .	3-4
Forced Landings . . . . .	3-4
Emergency Landing Without Engine Power . . . . .	3-4
Precautionary Landing With Engine Power . . . . .	3-4
Ditching . . . . .	3-5
Fires . . . . .	3-5
Engine Fire During Start On Ground . . . . .	3-5
Engine Fire In Flight . . . . .	3-6
Electrical Fire In Flight . . . . .	3-6
Cabin Fire . . . . .	3-6
Wing Fire . . . . .	3-7
Icing . . . . .	3-7
Inadvertent Icing Encounter . . . . .	3-7
Static Source Blockage (Erroneous Instrument Reading Suspected) . . . . .	3-8
Landing With A Flat Main Tire . . . . .	3-8
Electrical Power Supply System Malfunctions . . . . .	3-8
Over-Voltage Light Illuminates . . . . .	3-8
Ammeter Shows Discharge . . . . .	3-8
<b>AMPLIFIED PROCEDURES</b>	
Engine Failure . . . . .	3-9
Forced Landings . . . . .	3-10

## TABLE OF CONTENTS (Continued)

	Page
Landing Without Elevator Control . . . . .	3-10
Fires . . . . .	3-10
Emergency Operation In Clouds (Vacuum System Failure). . . . .	3-11
Executing A 180° Turn In Clouds . . . . .	3-11
Emergency Descent Through Clouds . . . . .	3-11
Recovery From A Spiral Dive . . . . .	3-12
Flight In Icing Conditions . . . . .	3-12
Static Source Blocked . . . . .	3-12
Spins . . . . .	3-13
Rough Engine Operation Or Loss Of Power . . . . .	3-13
Carburetor Icing . . . . .	3-13
Spark Plug Fouling . . . . .	3-14
Magneto Malfunction . . . . .	3-14
Low Oil Pressure . . . . .	3-14
Electrical Power Supply System Malfunctions . . . . .	3-15
Excessive Rate Of Charge . . . . .	3-15
Insufficient Rate Of Charge . . . . .	3-15

## INTRODUCTION

Section 3 provides checklist and amplified procedures for coping with emergencies that may occur. Emergencies caused by airplane or engine malfunctions are extremely rare if proper preflight inspections and maintenance are practiced. Enroute weather emergencies can be minimized or eliminated by careful flight planning and good judgement when unexpected weather is encountered. However, should an emergency arise the basic guidelines described in this section should be considered and applied as necessary to correct the problem. Emergency procedures associated with the ELT and other optional systems can be found in Section 9.

## AIRSPEEDS FOR SAFE OPERATION

Engine Failure After Takeoff:	
Wing Flaps Up . . . . .	65 KIAS
Wing Flaps Down . . . . .	60 KIAS
Maneuvering Speed:	
2300 Lbs . . . . .	97 KIAS
1950 Lbs . . . . .	89 KIAS
1600 Lbs . . . . .	80 KIAS
Maximum Glide:	
2300 Lbs . . . . .	65 KIAS
Precautionary Landing With Engine Power . . . . .	60 KIAS
Landing Without Engine Power:	
Wing Flaps Up . . . . .	65 KIAS
Wing Flaps Down . . . . .	60 KIAS

## OPERATIONAL CHECKLISTS

### ENGINE FAILURES

#### ENGINE FAILURE DURING TAKEOFF RUN

- (1) Throttle -- IDLE.
- (2) Brakes -- APPLY.
- (3) Wing Flaps -- RETRACT.
- (4) Mixture -- IDLE CUT-OFF.
- (5) Ignition Switch -- OFF.

#### ENGINE FAILURE IMMEDIATELY AFTER TAKEOFF

- (1) Airspeed -- 65 KIAS (flaps UP).  
60 KIAS (flaps DOWN).



- (2) Mixture -- IDLE CUT-OFF.
- (3) Fuel Selector Valve -- OFF.
- (4) Ignition Switch -- OFF.
- (5) Wing Flaps -- AS REQUIRED.
- (6) Master Switch -- OFF.

#### ENGINE FAILURE DURING FLIGHT

- (1) Airspeed -- 65 KIAS.
- (2) Carburetor Heat -- ON.
- (3) Fuel Selector Valve -- BOTH.
- (4) Mixture -- RICH.
- (5) Ignition Switch -- BOTH (or START if propeller is stopped).
- (6) Primer -- IN and LOCKED.

#### FORCED LANDINGS

##### EMERGENCY LANDING WITHOUT ENGINE POWER

- (1) Airspeed -- 65 KIAS (flaps UP).  
60 KIAS (flaps DOWN).
- (2) Mixture -- IDLE CUT-OFF.
- (3) Fuel Selector Valve -- OFF.
- (4) Ignition Switch -- OFF.
- (5) Wing Flaps -- AS REQUIRED (40° recommended).
- (6) Master Switch -- OFF.
- (7) Doors -- UNLATCH PRIOR TO TOUCHDOWN.
- (8) Touchdown -- SLIGHTLY TAIL LOW.
- (9) Brakes -- APPLY HEAVILY.

##### PRECAUTIONARY LANDING WITH ENGINE POWER

- (1) Wing Flaps -- 20°.
- (2) Airspeed -- 60 KIAS.
- (3) Selected Field -- FLY OVER, noting terrain and obstructions, then retract flaps upon reaching a safe altitude and airspeed.
- (4) Radio and Electrical Switches -- OFF.
- (5) Wing Flaps -- 40° (on final approach).
- (6) Airspeed -- 60 KIAS.
- (7) Master Switch -- OFF.
- (8) Doors -- UNLATCH PRIOR TO TOUCHDOWN.
- (9) Touchdown -- SLIGHTLY TAIL LOW.
- (10) Ignition Switch -- OFF.
- (11) Brakes -- APPLY HEAVILY.

#### DITCHING

- (1) Radio -- TRANSMIT MAYDAY on 121.5 MHz, giving location and intentions.
- (2) Heavy Objects (in baggage area) -- SECURE or JETTISON.
- (3) Flaps -- 20° - 40°.
- (4) Power -- ESTABLISH 300 FT/MIN DESCENT at 55 KIAS.
- (5) Approach -- High Winds, Heavy Seas -- INTO THE WIND.  
Light Winds, Heavy Swells -- PARALLEL TO SWELLS.

#### NOTE

If no power is available, approach at 65 KIAS with flaps up or at 60 KIAS with 10° flaps.

- (6) Cabin Doors -- UNLATCH.
- (7) Touchdown -- LEVEL ATTITUDE AT ESTABLISHED DESCENT.
- (8) Face -- CUSHION at touchdown with folded coat or seat cushion.
- (9) Airplane -- EVACUATE through cabin doors. If necessary, open window and flood cabin to equalize pressure so doors can be opened.
- (10) Life Vests and Raft -- INFLATE.

#### FIRES

##### ENGINE FIRE DURING START ON GROUND

- (1) Cranking -- CONTINUE, to get a start which would suck the flames and accumulated fuel through the carburetor and into the engine.

If engine starts:

- (2) Power -- 1700 RPM for a few minutes.
- (3) Engine -- SHUTDOWN and inspect for damage.

If engine fails to start:

- (4) Throttle -- FULL OPEN.
- (5) Mixture -- IDLE CUT-OFF.
- (6) Cranking -- CONTINUE for two or three minutes.
- (7) Fire Extinguisher -- OBTAIN (have ground attendants obtain if not installed).
- (8) Engine -- SECURE.
  - a. Master Switch -- OFF.

- b. Ignition Switch -- OFF.
- c. Fuel Shutoff Valve -- OFF.
- (9) Fire -- EXTINGUISH using fire extinguisher, seat cushion, wool blanket, or dirt. If practical try to remove carburetor air filter if it is ablaze.
- (10) Fire Damage -- INSPECT, repair damage or replace damaged components or wiring before conducting another flight.

#### ENGINE FIRE IN FLIGHT

- (1) Mixture -- IDLE CUT-OFF.
- (2) Fuel Selector Valve -- OFF.
- (3) Master Switch -- OFF.
- (4) Cabin Heat and Air -- OFF (except overhead vents).
- (5) Airspeed -- 100 KIAS (If fire is not extinguished, increase glide speed to find an airspeed which will provide an incombustible mixture).
- (6) Forced Landing -- EXECUTE (as described in Emergency Landing Without Engine Power).

#### ELECTRICAL FIRE IN FLIGHT

- (1) Master Switch -- OFF.
- (2) All Other Switches (except ignition switch) -- OFF.
- (3) Vents/Cabin Air/Heat -- CLOSED.
- (4) Fire Extinguisher -- ACTIVATE (if available).

If fire appears out and electrical power is necessary for continuance of flight:

- (5) Master Switch -- ON.
- (6) Circuit Breakers -- CHECK for faulty circuit, do not reset.
- (7) Radio/Electrical Switches -- ON one at a time, with delay after each until short circuit is localized.
- (8) Vents/Cabin Air/Heat -- OPEN when it is ascertained that fire is completely extinguished.

#### CABIN FIRE

- (1) Master Switch -- OFF.
- (2) Vents/Cabin Air/Heat -- CLOSED (to avoid drafts).
- (3) Fire Extinguisher -- ACTIVATE (if available).

### **WARNING**

After discharging an extinguisher within a closed cabin, ventilate the cabin.

- (4) Land the airplane as soon as possible to inspect for damage.

#### WING FIRE

- (1) Navigation Light Switch -- OFF.
- (2) Pitot Heat Switch (if installed) -- OFF.

#### NOTE

Perform a sideslip to keep the flames away from the fuel tank and cabin, and land as soon as possible using flaps only as required for final approach and touchdown.

#### ICING

##### INADVERTENT ICING ENCOUNTER

- (1) Turn pitot heat switch ON (if installed).
- (2) Turn back or change altitude to obtain an outside air temperature that is less conducive to icing.
- (3) Pull cabin heat control full out and open defroster outlet to obtain maximum windshield defroster airflow. Adjust cabin air control to get maximum defroster heat and airflow.
- (4) Open the throttle to increase engine speed and minimize ice build-up on propeller blades.
- (5) Watch for signs of carburetor air filter ice and apply carburetor heat as required. An unexplained loss in engine speed could be caused by carburetor ice or air intake filter ice. Lean the mixture for maximum RPM if carburetor heat is used continuously.
- (6) Plan a landing at the nearest airport. With an extremely rapid ice build-up, select a suitable "off airport" landing site.
- (7) With an ice accumulation of 1/4 inch or more on the wing leading edges, be prepared for significantly higher stall speed.
- (8) Leave wing flaps retracted. With a severe ice build-up on the horizontal tail, the change in wing wake airflow direction caused by wing flap extension could result in a loss of elevator effectiveness.
- (9) Open left window and, if practical, scrape ice from a portion of the windshield for visibility in the landing approach.
- (10) Perform a landing approach using a forward slip, if necessary, for improved visibility.
- (11) Approach at 65 to 75 KIAS, depending upon the amount of the accumulation.
- (12) Perform a landing in level attitude.

**STATIC SOURCE BLOCKAGE**  
(Erroneous Instrument Reading Suspected)

- (1) Alternate Static Source Valve -- PULL ON.
- (2) Airspeed -- Consult appropriate calibration tables in Section 5.

**LANDING WITH A FLAT MAIN TIRE**

- (1) Approach -- NORMAL.
- (2) Touchdown -- GOOD TIRE FIRST, hold airplane off flat tire as long as possible.

**ELECTRICAL POWER SUPPLY SYSTEM MALFUNCTIONS**

**OVER-VOLTAGE LIGHT ILLUMINATES**

- (1) Master Switch -- OFF (both sides).
- (2) Master Switch -- ON.
- (3) Over-Voltage Light -- OFF.

If over-voltage light illuminates again:

- (4) Flight -- TERMINATE as soon as possible.

**AMMETER SHOWS DISCHARGE**

- (1) Alternator -- OFF.
- (2) Nonessential Electrical Equipment -- OFF.
- (3) Flight -- TERMINATE as soon as practical.

**AMPLIFIED PROCEDURES**

**ENGINE FAILURE**

If an engine failure occurs during the takeoff run, the most important thing to do is stop the airplane on the remaining runway. Those extra items on the checklist will provide added safety during a failure of this type.

Prompt lowering of the nose to maintain airspeed and establish a glide attitude is the first response to an engine failure after takeoff. In most cases, the landing should be planned straight ahead with only small changes in direction to avoid obstructions. Altitude and airspeed are seldom sufficient to execute a 180° gliding turn necessary to return to the runway. The checklist procedures assume that adequate time exists to secure the fuel and ignition systems prior to touchdown.

After an engine failure in flight, the best glide speed as shown in Figure 3-1 should be established as quickly as possible. While gliding toward a suitable landing area, an effort should be made to identify the cause of the failure. If time permits, an engine restart should be attempted as shown in the checklist. If the engine cannot be restarted, a forced landing without power must be completed.

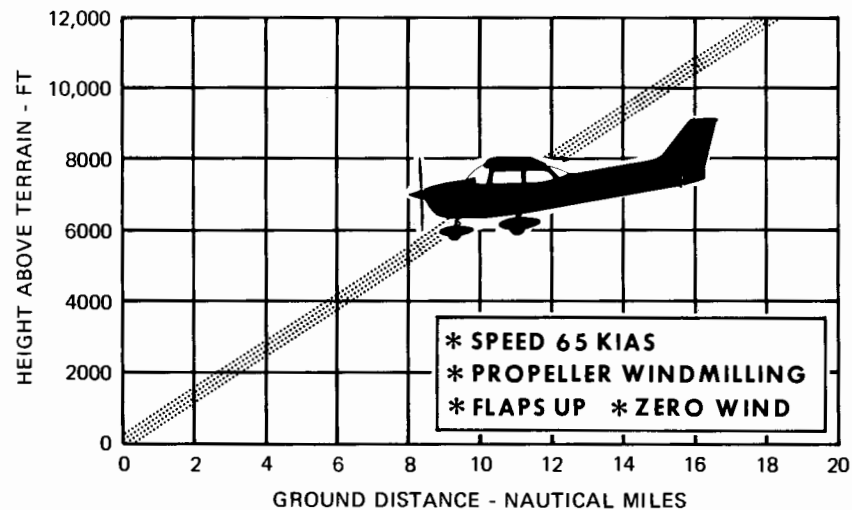

Figure 3-1. Maximum Glide

## FORCED LANDINGS

If all attempts to restart the engine fail and a forced landing is imminent, select a suitable field and prepare for the landing as discussed in the checklist for engine off emergency landings.

Before attempting an "off airport" landing with engine power available, one should drag the landing area at a safe but low altitude to inspect the terrain for obstructions and surface conditions, proceeding as discussed under the Precautionary Landing With Engine Power checklist.

Prepare for ditching by securing or jettisoning heavy objects located in the baggage area and collect folded coats or cushions for protection of occupants' face at touchdown. Transmit Mayday message on 121.5 MHz giving location and intentions. Avoid a landing flare because of difficulty in judging height over a water surface.

## LANDING WITHOUT ELEVATOR CONTROL

Trim for horizontal flight (with an airspeed of approximately 60 KIAS and flaps set to 20°) by using throttle and elevator trim control. Then do not change the elevator trim control setting; control the glide angle by adjusting power exclusively.

At flareout the nose-down moment resulting from power reduction is an adverse factor and the airplane may hit on the nose wheel. Consequently, at flareout, the elevator trim control should be adjusted toward the full nose-up position and the power adjusted so that the airplane will rotate to the horizontal attitude for touchdown. Close the throttle at touchdown.

## FIRES

Although engine fires are extremely rare in flight, the steps of the appropriate checklist should be followed if one is encountered. After completion of this procedure, execute a forced landing.

The initial indication of an electrical fire is usually the odor of burning insulation. The checklist for this problem should result in elimination of the fire.

## EMERGENCY OPERATION IN CLOUDS (Vacuum System Failure)

In the event of a vacuum system failure during flight in marginal weather, the directional indicator and attitude indicator will be disabled, and the pilot will have to rely on the turn coordinator or the turn and bank indicator if he inadvertently flies into clouds. The following instructions assume that only the electrically-powered turn coordinator or the turn and bank indicator is operative, and that the pilot is not completely proficient in instrument flying.

### EXECUTING A 180° TURN IN CLOUDS

Upon inadvertently entering the clouds, an immediate plan should be made to turn back as follows:

- (1) Note the time of the minute hand and observe the position of the sweep second hand on the clock.
- (2) When the sweep second hand indicates the nearest half-minute, initiate a standard rate left turn, holding the turn coordinator symbolic airplane wing opposite the lower left index mark for 60 seconds. Then roll back to level flight by leveling the miniature airplane.
- (3) Check accuracy of the turn by observing the compass heading which should be the reciprocal of the original heading.
- (4) If necessary, adjust heading primarily with skidding motions rather than rolling motions so that the compass will read more accurately.
- (5) Maintain altitude and airspeed by cautious application of elevator control. Avoid overcontrolling by keeping the hands off the control wheel and steering only with rudder.

### EMERGENCY DESCENT THROUGH CLOUDS

If conditions preclude reestablishment of VFR flight by a 180° turn, a descent through a cloud deck to VFR conditions may be appropriate. If possible, obtain radio clearance for an emergency descent through clouds. To guard against a spiral dive, choose an easterly or westerly heading to minimize compass card swings due to changing bank angles. In addition, keep hands off the control wheel and steer a straight course with rudder control by monitoring the turn coordinator. Occasionally check the compass heading and make minor corrections to hold an approximate course. Before descending into the clouds, set up a stabilized let-down condition as follows:

- (1) Apply full rich mixture.
- (2) Use full carburetor heat.

- (3) Reduce power to set up a 500 to 800 ft/min rate of descent.
- (4) Adjust the elevator trim for a stabilized descent at 70-80 KIAS.
- (5) Keep hands off the control wheel.
- (6) Monitor turn coordinator and make corrections by rudder alone.
- (7) Check trend of compass card movement and make cautious corrections with rudder to stop the turn.
- (8) Upon breaking out of clouds, resume normal cruising flight.

### RECOVERY FROM A SPIRAL DIVE

If a spiral is encountered, proceed as follows:

- (1) Close the throttle.
- (2) Stop the turn by using coordinated aileron and rudder control to align the symbolic airplane in the turn coordinator with the horizon reference line.
- (3) Cautiously apply elevator back pressure to slowly reduce the airspeed to 80 KIAS.
- (4) Adjust the elevator trim control to maintain an 80 KIAS glide.
- (5) Keep hands off the control wheel, using rudder control to hold a straight heading.
- (6) Apply carburetor heat.
- (7) Clear engine occasionally, but avoid using enough power to disturb the trimmed glide.
- (8) Upon breaking out of clouds, resume normal cruising flight.

### FLIGHT IN ICING CONDITIONS

Flight into icing conditions is prohibited. An inadvertent encounter with these conditions can best be handled using the checklist procedures. The best procedure, of course, is to turn back or change altitude to escape icing conditions.

### STATIC SOURCE BLOCKED

If erroneous readings of the static source instruments (airspeed, altimeter and rate-of-climb) are suspected, the alternate static source valve should be pulled on, thereby supplying static pressure to these instruments from the cabin.

#### NOTE

In an emergency on airplanes not equipped with an alternate static source, cabin pressure can be supplied to the static pressure instruments by breaking the glass in the face of the rate-of-climb indicator.

With the alternate static source on, adjust indicated airspeed slightly during climb or approach according to the alternate static source airspeed calibration table in Section 5, appropriate to vent/window(s) configuration, causing the airplane to be flown at the normal operating speeds.

Maximum airspeed and altimeter variation from normal is 4 knots and 30 feet over the normal operating range with the window(s) closed. With window(s) open, larger variations occur near stall speed. However, maximum altimeter variation remains within 50 feet of normal.

### SPINS

Should an inadvertent spin occur, the following recovery procedure should be used:

- (1) RETARD THROTTLE TO IDLE POSITION.
- (2) PLACE AILERONS IN NEUTRAL POSITION.
- (3) APPLY AND HOLD FULL RUDDER OPPOSITE TO THE DIRECTION OF ROTATION.
- (4) JUST AFTER THE RUDDER REACHES THE STOP, MOVE THE CONTROL WHEEL BRISKLY FORWARD FAR ENOUGH TO BREAK THE STALL. Full down elevator may be required at aft center of gravity loadings to assure optimum recoveries.
- (5) HOLD THESE CONTROL INPUTS UNTIL ROTATION STOPS. Premature relaxation of the control inputs may extend the recovery.
- (6) AS ROTATION STOPS, NEUTRALIZE RUDDER, AND MAKE A SMOOTH RECOVERY FROM THE RESULTING DIVE.

#### NOTE

If disorientation precludes a visual determination of the direction of rotation, the symbolic airplane in the turn coordinator or the needle of the turn and bank indicator may be referred to for this information.

For additional information on spins and spin recovery, see the discussion under SPINS in Normal Procedures (Section 4).

### ROUGH ENGINE OPERATION OR LOSS OF POWER

#### CARBURETOR ICING

A gradual loss of RPM and eventual engine roughness may result from

the formation of carburetor ice. To clear the ice, apply full throttle and pull the carburetor heat knob full out until the engine runs smoothly; then remove carburetor heat and readjust the throttle. If conditions require the continued use of carburetor heat in cruise flight, use the minimum amount of heat necessary to prevent ice from forming and lean the mixture for smoothest engine operation.

### SPARK PLUG FOULING

A slight engine roughness in flight may be caused by one or more spark plugs becoming fouled by carbon or lead deposits. This may be verified by turning the ignition switch momentarily from BOTH to either L or R position. An obvious power loss in single ignition operation is evidence of spark plug or magneto trouble. Assuming that spark plugs are the more likely cause, lean the mixture to the recommended lean setting for cruising flight. If the problem does not clear up in several minutes, determine if a richer mixture setting will produce smoother operation. If not, proceed to the nearest airport for repairs using the BOTH position of the ignition switch unless extreme roughness dictates the use of a single ignition position.

### MAGNETO MALFUNCTION

A sudden engine roughness or misfiring is usually evidence of magneto problems. Switching from BOTH to either L or R ignition switch position will identify which magneto is malfunctioning. Select different power settings and enrichen the mixture to determine if continued operation on BOTH magnetos is practicable. If not, switch to the good magneto and proceed to the nearest airport for repairs.

### LOW OIL PRESSURE

If low oil pressure is accompanied by normal oil temperature, there is a possibility the oil pressure gage or relief valve is malfunctioning. A leak in the line to the gage is not necessarily cause for an immediate precautionary landing because an orifice in this line will prevent a sudden loss of oil from the engine sump. However, a landing at the nearest airport would be advisable to inspect the source of trouble.

If a total loss of oil pressure is accompanied by a rise in oil temperature, there is good reason to suspect an engine failure is imminent. Reduce engine power immediately and select a suitable forced landing field. Use only the minimum power required to reach the desired touchdown spot.

## ELECTRICAL POWER SUPPLY SYSTEM MALFUNCTIONS

Malfunctions in the electrical power supply system can be detected by periodic monitoring of the ammeter and over-voltage warning light; however, the cause of these malfunctions is usually difficult to determine. A broken alternator drive belt or wiring is most likely the cause of alternator failures, although other factors could cause the problem. A damaged or improperly adjusted voltage regulator can also cause malfunctions. Problems of this nature constitute an electrical emergency and should be dealt with immediately. Electrical power malfunctions usually fall into two categories: excessive rate of charge and insufficient rate of charge. The following paragraphs describe the recommended remedy for each situation.

### EXCESSIVE RATE OF CHARGE

After engine starting and heavy electrical usage at low engine speeds (such as extended taxiing) the battery condition will be low enough to accept above normal charging during the initial part of a flight. However, after thirty minutes of cruising flight, the ammeter should be indicating less than two needle widths of charging current. If the charging rate were to remain above this value on a long flight, the battery would overheat and evaporate the electrolyte at an excessive rate. Electronic components in the electrical system could be adversely affected by higher than normal voltage if a faulty voltage regulator setting is causing the overcharging. To preclude these possibilities, an over-voltage sensor will automatically shut down the alternator and the over-voltage warning light will illuminate if the charge voltage reaches approximately 16 volts. Assuming that the malfunction was only momentary, an attempt should be made to reactivate the alternator system. To do this, turn both sides of the master switch off and then on again. If the problem no longer exists, normal alternator charging will resume and the warning light will go off. If the light comes on again, a malfunction is confirmed. In this event, the flight should be terminated and/or the current drain on the battery minimized because the battery can supply the electrical system for only a limited period of time. If the emergency occurs at night, power must be conserved for later use of landing lights and flaps during landing.

### INSUFFICIENT RATE OF CHARGE

If the ammeter indicates a continuous discharge rate in flight, the alternator is not supplying power to the system and should be shut down since the alternator field circuit may be placing an unnecessary load on the system. All nonessential equipment should be turned off and the flight terminated as soon as practical.

# SECTION 4 NORMAL PROCEDURES

## TABLE OF CONTENTS

	Page
Introduction . . . . .	4-3
Speeds For Safe Operation . . . . .	4-3

### CHECKLIST PROCEDURES

Preflight Inspection . . . . .	4-5
Cabin . . . . .	4-5
Empennage . . . . .	4-5
Right Wing, Trailing Edge . . . . .	4-5
Right Wing . . . . .	4-5
Nose . . . . .	4-5
Left Wing . . . . .	4-6
Left Wing, Leading Edge . . . . .	4-6
Left Wing, Trailing Edge . . . . .	4-6
Before Starting Engine . . . . .	4-6
Starting Engine . . . . .	4-6
Before Takeoff . . . . .	4-7
Takeoff . . . . .	4-7
Normal Takeoff . . . . .	4-7
Maximum Performance Takeoff . . . . .	4-7
Enroute Climb . . . . .	4-8
Cruise . . . . .	4-8
Descent . . . . .	4-8
Before Landing . . . . .	4-8
Balked Landing . . . . .	4-9
Normal Landing . . . . .	4-9
After Landing . . . . .	4-9
Securing Airplane . . . . .	4-9

### AMPLIFIED PROCEDURES

Starting Engine . . . . .	4-11
---------------------------	------

**TABLE OF CONTENTS (Continued)**

	Page
Taxiing . . . . .	4-11
Before Takeoff . . . . .	4-13
Warm-Up . . . . .	4-13
Magneto Check . . . . .	4-13
Alternator Check . . . . .	4-13
Takeoff . . . . .	4-13
Power Check . . . . .	4-13
Wing Flap Settings . . . . .	4-14
Crosswind Takeoffs . . . . .	4-15
Enroute Climb . . . . .	4-15
Cruise . . . . .	4-15
Stalls . . . . .	4-17
Spins . . . . .	4-17
Landing . . . . .	4-19
Normal Landing . . . . .	4-19
Short Field Landing . . . . .	4-19
Crosswind Landing . . . . .	4-20
Balked Landing . . . . .	4-20
Cold Weather Operation . . . . .	4-20
Starting . . . . .	4-20
Flight Operations . . . . .	4-22
Hot Weather Operation . . . . .	4-23
Noise Abatement . . . . .	4-23

**INTRODUCTION**

Section 4 provides checklist and amplified procedures for the conduct of normal operation. Normal procedures associated with Optional Systems can be found in Section 9.

**SPEEDS FOR SAFE OPERATION**

Unless otherwise noted, the following speeds are based on a maximum weight of 2300 pounds and may be used for any lesser weight. However, to achieve the performance specified in Section 5 for takeoff distance, the speed appropriate to the particular weight must be used.

<b>Takeoff, Flaps Up:</b>	
Normal Climb Out . . . . .	70-80 KIAS
Maximum Performance Takeoff, Speed at 50 feet . . . . .	59 KIAS
<b>Enroute Climb, Flaps Up:</b>	
Normal, Sea Level . . . . .	80-90 KIAS
Normal, 10,000 Feet . . . . .	70-80 KIAS
Best Rate of Climb, Sea Level . . . . .	78 KIAS
Best Rate of Climb, 10,000 Feet . . . . .	68 KIAS
Best Angle of Climb, Sea Level . . . . .	64 KIAS
Best Angle of Climb, 10,000 Feet . . . . .	62 KIAS
<b>Landing Approach:</b>	
Normal Approach, Flaps Up . . . . .	60-70 KIAS
Normal Approach, Flaps 40° . . . . .	55-65 KIAS
Short Field Approach, Flaps 40° . . . . .	60 KIAS
<b>Balked Landing:</b>	
During Transition to Maximum Power, Flaps 20° . . . . .	55 KIAS
<b>Maximum Recommended Turbulent Air Penetration Speed:</b>	
2300 Lbs . . . . .	97 KIAS
1950 Lbs . . . . .	89 KIAS
1600 Lbs . . . . .	80 KIAS
<b>Maximum Demonstrated Crosswind Velocity:</b>	
Takeoff or Landing . . . . .	15 KNOTS



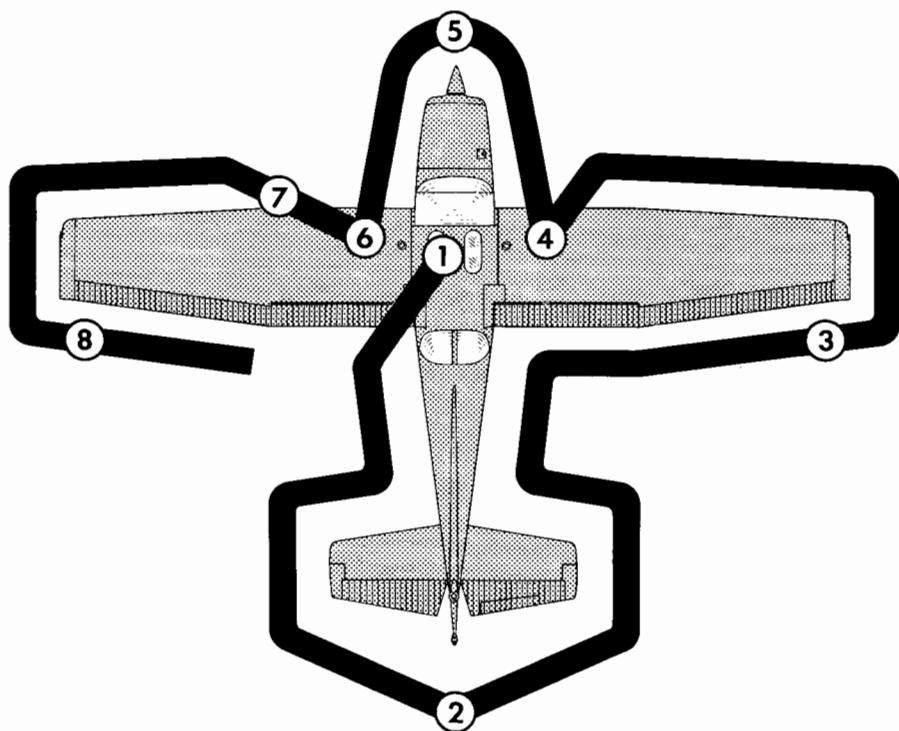

**NOTE**

Visually check airplane for general condition during walk-around inspection. In cold weather, remove even small accumulations of frost, ice or snow from wing, tail and control surfaces. Also, make sure that control surfaces contain no internal accumulations of ice or debris. If a night flight is planned, check operation of all lights, and make sure a flashlight is available.

Figure 4-1. Preflight Inspection

## CHECKLIST PROCEDURES

### PREFLIGHT INSPECTION

#### ① CABIN

- (1) Control Wheel Lock -- REMOVE.
- (2) Ignition Switch -- OFF.
- (3) Master Switch -- ON.
- (4) Fuel Quantity Indicators -- CHECK QUANTITY.
- (5) Master Switch -- OFF.
- (6) Baggage Door -- CHECK, lock with key if child's seat is to be occupied.

#### ② EMPENNAGE

- (1) Rudder Gust Lock -- REMOVE.
- (2) Tail Tie-Down -- DISCONNECT.
- (3) Control Surfaces -- CHECK freedom of movement and security.

#### ③ RIGHT WING Trailing Edge

- (1) Aileron -- CHECK freedom of movement and security.

#### ④ RIGHT WING

- (1) Wing Tie-Down -- DISCONNECT.
- (2) Main Wheel Tire --- CHECK for proper inflation.
- (3) Before first flight of the day and after each refueling, use sampler cup and drain small quantity of fuel from fuel tank sump quick-drain valve to check for water, sediment, and proper fuel grade (red).
- (4) Fuel Quantity -- CHECK VISUALLY for desired level.
- (5) Fuel Filler Cap -- SECURE.

#### ⑤ NOSE

- (1) Engine Oil Level -- CHECK. Do not operate with less than six quarts. Fill to eight quarts for extended flight.
- (2) Before first flight of the day and after each refueling, pull out strainer drain knob for about four seconds to clear fuel strainer of possible water and sediment. Check strainer drain closed. If water is observed, the fuel system may contain additional tank water, and further draining of the system at the strainer, fuel tank sumps, and fuel

selector valve drain plug will be necessary.

- (3) Propeller and Spinner -- CHECK for nicks and security.
- (4) Landing Light(s) -- CHECK for condition and cleanliness.
- (5) Carburetor Air Filter -- CHECK for restrictions by dust or other foreign matter.
- (6) Nose Wheel Strut and Tire -- CHECK for proper inflation.
- (7) Nose Tie-Down -- DISCONNECT.
- (8) Flight Instrument Static Source Opening (left side of fuselage) -- CHECK for stoppage.

#### ⑥ LEFT WING

- (1) Main Wheel Tire -- CHECK for proper inflation.
- (2) Before first flight of the day and after each refueling, use sampler cup and drain small quantity of fuel from fuel tank sump quick-drainvalve to check for water, sediment and proper fuel grade (red).
- (3) Fuel Quantity -- CHECK VISUALLY for desired level.
- (4) Fuel Filler Cap -- SECURE.

#### ⑦ LEFT WING Leading Edge

- (1) Pitot Tube Cover -- REMOVE and check opening for stoppage.
- (2) Fuel Tank Vent Opening -- CHECK for stoppage.
- (3) Stall Warning Opening -- CHECK for stoppage. To check the system, place a clean handkerchief over the vent opening and apply suction; a sound from the warning horn will confirm system operation.
- (4) Wing Tie-Down -- DISCONNECT.

#### ⑧ LEFT WING Trailing Edge

- (1) Aileron -- CHECK for freedom of movement and security.

### BEFORE STARTING ENGINE

- (1) Preflight Inspection -- COMPLETE.
- (2) Seats, Belts, Shoulder Harnesses -- ADJUST and LOCK.
- (3) Fuel Selector Valve -- BOTH.
- (4) Radios, Autopilot, Electrical Equipment -- OFF.
- (5) Brakes -- TEST and SET.
- (6) Circuit Breakers -- CHECK IN.

### STARTING ENGINE

- (1) Mixture -- RICH.

- (2) Carburetor Heat -- COLD.
- (3) Master Switch -- ON.
- (4) Prime -- AS REQUIRED (2 to 6 strokes; none if engine is warm).
- (5) Throttle -- OPEN 1/8 INCH.
- (6) Propeller Area -- CLEAR.
- (7) Ignition Switch -- START (release when engine starts).
- (8) Oil Pressure -- CHECK.

### BEFORE TAKEOFF

- (1) Cabin Doors and Window(s) -- CLOSED and LOCKED.
- (2) Flight Controls -- FREE and CORRECT.
- (3) Elevator Trim -- TAKEOFF.
- (4) Flight Instruments -- SET.
- (5) Radios -- SET.
- (6) Autopilot (if installed) -- OFF.
- (7) Fuel Selector Valve -- BOTH.
- (8) Mixture -- RICH (below 3000 feet).
- (9) Parking Brake -- SET.
- (10) Throttle -- 1700 RPM.
  - a. Magnetos -- CHECK (RPM drop should not exceed 125 RPM on either magneto or 50 RPM differential between magnetos).
  - b. Carburetor Heat -- CHECK (for RPM drop).
  - c. Engine Instruments and Ammeter -- CHECK.
  - d. Suction Gage -- CHECK.
- (11) Flashing Beacon, Navigation Lights and/or Strobe Lights -- ON as required.
- (12) Throttle Friction Lock -- ADJUST.
- (13) Wing Flaps -- UP.

### TAKEOFF

#### NORMAL TAKEOFF

- (1) Wing Flaps -- UP.
- (2) Carburetor Heat -- COLD.
- (3) Throttle -- FULL.
- (4) Elevator Control -- LIFT NOSE WHEEL (at 55 KIAS).
- (5) Climb Speed -- 70-80 KIAS.

#### MAXIMUM PERFORMANCE TAKEOFF

- (1) Wing Flaps -- UP.

- (2) Carburetor Heat -- COLD.
- (3) Brakes -- APPLY.
- (4) Throttle -- FULL OPEN.
- (5) Brakes -- RELEASE.
- (6) Elevator Control -- SLIGHTLY TAIL LOW.
- (7) Climb Speed -- 59 KIAS (until all obstacles are cleared).

## ENROUTE CLIMB

- (1) Airspeed -- 70-90 KIAS.

### NOTE

If a maximum performance climb is necessary, use speeds shown in the Rate Of Climb chart in Section 5.

- (2) Throttle -- FULL OPEN.
- (3) Mixture -- FULL RICH (mixture may be leaned above 3000 feet).

## CRUISE

- (1) Power -- 2200-2700 RPM (no more than 75%).
- (2) Elevator Trim -- ADJUST.
- (3) Mixture -- LEAN.

## DESCENT

- (1) Mixture -- RICH.
- (2) Power -- AS DESIRED.
- (3) Carburetor Heat -- AS REQUIRED (to prevent carburetor icing).

## BEFORE LANDING

- (1) Fuel Selector Valve -- BOTH.
- (2) Mixture -- RICH.
- (3) Carburetor Heat -- ON (apply full heat before closing throttle).
- (4) Airspeed -- 60-70 KIAS (flaps UP).

- (5) Wing Flaps -- AS DESIRED.
- (6) Airspeed -- 55-65 KIAS (flaps DOWN).

## BALKED LANDING

- (1) Throttle -- FULL OPEN.
- (2) Carburetor Heat -- COLD.
- (3) Wing Flaps -- 20°.
- (4) Airspeed -- 55 KIAS.
- (5) Wing Flaps -- RETRACT slowly.

## NORMAL LANDING

- (1) Touchdown -- MAIN WHEELS FIRST.
- (2) Landing Roll -- LOWER NOSE WHEEL GENTLY.
- (3) Braking -- MINIMUM REQUIRED.

## AFTER LANDING

- (1) Wing Flaps -- UP.
- (2) Carburetor Heat -- COLD.

## SECURING AIRPLANE

- (1) Parking Brake -- SET.
- (2) Radios, Electrical Equipment, Autopilot -- OFF.
- (3) Mixture -- IDLE CUT-OFF (pulled full out).
- (4) Ignition Switch -- OFF.
- (5) Master Switch -- OFF.
- (6) Control Lock -- INSTALL.

## AMPLIFIED PROCEDURES

### STARTING ENGINE

During engine starting, open the throttle approximately 1/8 inch. In warm temperatures, one or two strokes of the primer should be sufficient. In cold weather, up to six strokes of the primer may be necessary. If the engine is warm, no priming will be required. In extremely cold temperatures, it may be necessary to continue priming while cranking the engine.

Weak intermittent firing followed by puffs of black smoke from the exhaust stack indicate overpriming or flooding. Excess fuel can be cleared from the combustion chambers by the following procedure: Set the mixture control full lean and the throttle full open; then crank the engine through several revolutions with the starter. Repeat the starting procedure without any additional priming.

If the engine is underprimed (most likely in cold weather with a cold engine) it will not fire at all, and additional priming will be necessary. As soon as the cylinders begin to fire, open the throttle slightly to keep it running.

After starting, if the oil gage does not begin to show pressure within 30 seconds in the summertime and about twice that long in very cold weather, stop engine and investigate. Lack of oil pressure can cause serious engine damage. After starting, avoid the use of carburetor heat unless icing conditions prevail.

#### NOTE

Additional details concerning cold weather starting and operation may be found under COLD WEATHER OPERATION paragraphs in this section.

### TAXIING

When taxiing, it is important that speed and use of brakes be held to a minimum and that all controls be utilized (see Taxiing Diagram, figure 4-2) to maintain directional control and balance.

The carburetor heat control knob should be pushed full in during all ground operations unless heat is absolutely necessary. When the knob is

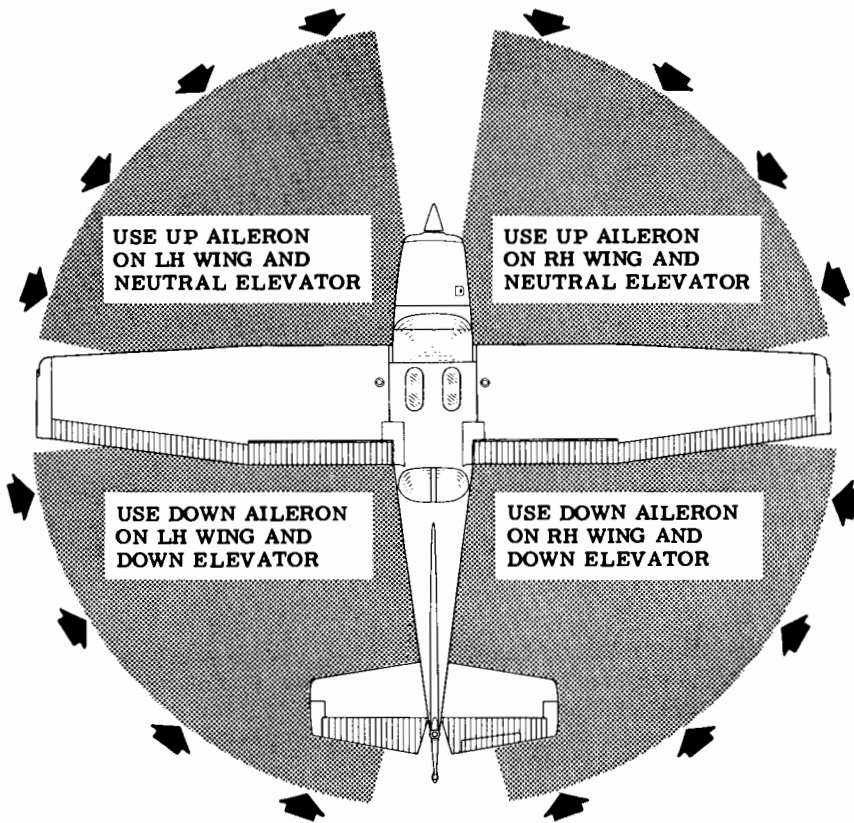

**CODE**

WIND DIRECTION →

**NOTE**

Strong quartering tail winds require caution. Avoid sudden bursts of the throttle and sharp braking when the airplane is in this attitude. Use the steerable nose wheel and rudder to maintain direction.

Figure 4-2. Taxiing Diagram

pulled out to the heat position, air entering the engine is not filtered.

Taxiing over loose gravel or cinders should be done at low engine speed to avoid abrasion and stone damage to the propeller tips.

**BEFORE TAKEOFF**

**WARM-UP**

If the engine accelerates smoothly, the airplane is ready for takeoff. Since the engine is closely cowled for efficient in-flight engine cooling, precautions should be taken to avoid overheating during prolonged engine operation on the ground. Also, long periods of idling may cause fouled spark plugs.

**MAGNETO CHECK**

The magneto check should be made at 1700 RPM as follows. Move ignition switch first to R position and note RPM. Next move switch back to BOTH to clear the other set of plugs. Then move switch to the L position, note RPM and return the switch to the BOTH position. RPM drop should not exceed 125 RPM on either magneto or show greater than 50 RPM differential between magnetos. If there is a doubt concerning operation of the ignition system, RPM checks at higher engine speeds will usually confirm whether a deficiency exists.

An absence of RPM drop may be an indication of faulty grounding of one side of the ignition system or should be cause for suspicion that the magneto timing is set in advance of the setting specified.

**ALTERNATOR CHECK**

Prior to flights where verification of proper alternator and voltage regulator operation is essential (such as night or instrument flights), a positive verification can be made by loading the electrical system momentarily (3 to 5 seconds) with the optional landing light (if so equipped), or by operating the wing flaps during the engine runup (1700 RPM). The ammeter will remain within a needle width of zero if the alternator and voltage regulator are operating properly.

**TAKEOFF**

**POWER CHECK**

It is important to check full-throttle engine operation early in the

takeoff run. Any sign of rough engine operation or sluggish engine acceleration is good cause for discontinuing the takeoff. If this occurs, you are justified in making a thorough full-throttle, static runup before another takeoff is attempted. The engine should run smoothly and turn approximately 2300 to 2420 RPM with carburetor heat off and mixture full rich.

#### NOTE

Carburetor heat should not be used during takeoff unless it is absolutely necessary for obtaining smooth engine acceleration.

Full-throttle runups over loose gravel are especially harmful to propeller tips. When takeoffs must be made over a gravel surface, it is very important that the throttle be advanced slowly. This allows the airplane to start rolling before high RPM is developed, and the gravel will be blown back of the propeller rather than pulled into it. When unavoidable small dents appear in the propeller blades, they should be immediately corrected as described in Section 8 under Propeller Care.

Prior to takeoff from fields above 3000 feet elevation, the mixture should be leaned to give maximum RPM in a full-throttle, static runup.

After full throttle is applied, adjust the throttle friction lock clockwise to prevent the throttle from creeping back from a maximum power position. Similar friction lock adjustments should be made as required in other flight conditions to maintain a fixed throttle setting.

#### WING FLAP SETTINGS

Normal and obstacle clearance takeoffs are performed with wing flaps up. The use of 10° flaps will shorten the ground run approximately 10%, but this advantage is lost in the climb to a 50-foot obstacle. Therefore, the use of 10° flaps is reserved for minimum ground runs or for takeoff from soft or rough fields. If 10° of flaps are used for minimum ground runs, it is preferable to leave them extended rather than retract them in the climb to the obstacle. In this case use an obstacle clearance speed of 55 KIAS. As soon as the obstacle is cleared, the flaps may be retracted as the aircraft accelerates to the normal flaps-up climb-out speed.

During a high altitude takeoff in hot weather where climb would be marginal with 10° flaps, it is recommended that the flaps not be used for takeoff. Flap settings greater than 10° are not approved for takeoff.

#### CROSSWIND TAKEOFFS

Takeoffs into strong crosswinds normally are performed with the minimum flap setting necessary for the field length to minimize the drift angle immediately after takeoff. The airplane is accelerated to a speed slightly higher than normal, then pulled off abruptly to prevent possible settling back to the runway while drifting. When clear of the ground, make a coordinated turn into the wind to correct for drift.

#### ENROUTE CLIMB

Normal climbs are performed with flaps up and full throttle and at speeds 5 to 10 knots higher than best rate-of-climb speeds for the best combination of performance, visibility and engine cooling. The mixture should be full rich below 3000 feet and may be leaned above 3000 feet for smoother operation or to obtain maximum RPM. If an obstruction dictates the use of a steep climb angle, the best angle-of-climb speed should be used with flaps up and maximum power.

#### NOTE

Climbs at speeds lower than the best rate-of-climb speed should be of short duration to improve engine cooling.

#### CRUISE

Normal cruising is performed between 55% and 75% power. The engine RPM and corresponding fuel consumption for various altitudes can be determined by using your Cessna Power Computer or the data in Section 5.

#### NOTE

Cruising should be done at 65% to 75% power until a total of 50 hours has accumulated or oil consumption has stabilized. This is to ensure proper seating of the rings and is applicable to new engines, and engines in service following cylinder replacement or top overhaul of one or more cylinders.

The Cruise Performance Table, Figure 4-3, illustrates the true air-speed and nautical miles per gallon during cruise for various altitudes and percent power. This table should be used as a guide, along with the avail-

ALTITUDE	75% POWER		65% POWER		55% POWER	
	KTAS	NMPG	KTAS	NMPG	KTAS	NMPG
Sea Level	112	13.5	106	14.7	97	15.2
4000 Feet	116	14.0	109	15.1	99	15.5
8000 Feet	120	14.5	112	15.6	102	15.9
Standard Conditions						Zero Wind

Figure 4-3. Cruise Performance Table

able winds aloft information, to determine the most favorable altitude and power setting for a given trip. The selection of cruise altitude on the basis of the most favorable wind conditions and the use of low power settings are significant factors that should be considered on every trip to reduce fuel consumption.

To achieve the recommended lean mixture fuel consumption figures shown in Section 5, the mixture should be leaned as follows:

- (1) Pull the mixture control out until engine RPM peaks and begins to fall off.
- (2) Enrichen slightly back to peak RPM.

For best fuel economy at 75% power or less, operate at the leanest mixture that results in smooth engine operation or at 50 RPM on the lean side of the peak RPM, whichever occurs first. This will result in approximately 5% greater range than shown in this handbook.

Carburetor ice, as evidenced by an unexplained drop in RPM, can be removed by application of full carburetor heat. Upon regaining the original RPM (with heat off), use the minimum amount of heat (by trial and error) to prevent ice from forming. Since the heated air causes a richer mixture, readjust the mixture setting when carburetor heat is to be used continuously in cruise flight.

The use of full carburetor heat is recommended during flight in heavy rain to avoid the possibility of engine stoppage due to excessive water ingestion or carburetor ice. The mixture setting should be readjusted for smoothest operation.

In extremely heavy rain, the use of partial carburetor heat (control

approximately 2/3 out), and part throttle (closed at least one inch), may be necessary to retain adequate power. Power changes should be made cautiously followed by prompt adjustment of the mixture for smoothest operation.

## STALLS

The stall characteristics are conventional and aural warning is provided by a stall warning horn which sounds between 5 and 10 knots above the stall in all configurations.

Power-off stall speeds at maximum weight for both forward and aft c.g. positions are presented in Section 5.

## SPINS

Intentional spins are approved in this airplane within certain restricted loadings. Spins with baggage loadings or occupied rear seat(s) are not approved.

However, before attempting to perform spins several items should be carefully considered to assure a safe flight. No spins should be attempted without first having received dual instruction both in spin entries and spin recoveries from a qualified instructor who is familiar with the spin characteristics of the Cessna 172M.

The cabin should be clean and all loose equipment (including the microphone and rear seat belts) should be stowed or secured. For a solo flight in which spins will be conducted, the copilot's seat belt and shoulder harness should also be secured. The seat belts and shoulder harnesses should be adjusted to provide proper restraint during all anticipated flight conditions. However, care should be taken to ensure that the pilot can easily reach the flight controls and produce maximum control travels.

It is recommended that, where feasible, entries be accomplished at high enough altitude that recoveries are completed 4000 feet or more above ground level. At least 1000 feet of altitude loss should be allowed for a 1- turn spin and recovery, while a 6- turn spin and recovery may require somewhat more than twice that amount. For example, the recommended entry altitude for a 6- turn spin would be 6000 feet above ground level. In any case, entries should be planned so that recoveries are completed well above the minimum 1500 feet above ground level required by FAR 91.71. Another reason for using high altitudes for practicing spins is that a

greater field of view is provided which will assist in maintaining pilot orientation.

The normal entry is made from a power-off stall. As the stall is approached, the elevator control should be smoothly pulled to the full aft position. Just prior to reaching the stall "break", rudder control in the desired direction of the spin rotation should be applied so that full rudder deflection is reached almost simultaneously with reaching full aft elevator. A slightly greater rate of deceleration than for normal stall entries, application of ailerons in the direction of the desired spin, and the use of power at the entry will assure more consistent and positive entries to the spin. As the airplane begins to spin, reduce the power to idle and return the ailerons to neutral. Both elevator and rudder controls should be held full with the spin until the spin recovery is initiated. An inadvertent relaxation of either of these controls could result in the development of a nose-down spiral.

For the purpose of training in spins and spin recoveries, a 1 or 2 turn spin is adequate and should be used. Up to 2 turns, the spin will progress to a fairly rapid rate of rotation and a steep attitude. Application of recovery controls will produce prompt recoveries (within 1/4 turn). During extended spins of two to three turns or more, the spin will tend to change into a spiral, particularly to the right. This will be accompanied by an increase in airspeed and gravity loads on the airplane. If this occurs, recovery should be accomplished quickly by leveling the wings and recovering from the resulting dive.

Regardless of how many turns the spin is held or how it is entered, the following recovery technique should be used:

- (1) VERIFY THAT THROTTLE IS IN IDLE POSITION AND AILERONS ARE NEUTRAL.
- (2) APPLY AND HOLD FULL RUDDER OPPOSITE TO THE DIRECTION OF ROTATION.
- (3) JUST AFTER THE RUDDER REACHES THE STOP, MOVE THE CONTROL WHEEL BRISKLY FORWARD FAR ENOUGH TO BREAK THE STALL.
- (4) HOLD THESE CONTROL INPUTS UNTIL ROTATION STOPS.
- (5) AS ROTATION STOPS, NEUTRALIZE RUDDER, AND MAKE A SMOOTH RECOVERY FROM THE RESULTING DIVE.

#### NOTE

If disorientation precludes a visual determination of the direction of rotation, the symbolic airplane in the turn

coordinator or the needle of the turn and bank indicator may be referred to for this information.

Variation in basic airplane rigging or in weight and balance due to installed equipment or right seat occupancy can cause differences in behavior, particularly in extended spins. These differences are normal and will result in variations in the spin characteristics and in the spiraling tendencies for spins of more than 2 turns. However, the recovery technique should always be used and will result in the most expeditious recovery from any spin.

Intentional spins with flaps extended are prohibited, since the high speeds which may occur during recovery are potentially damaging to the flap/wing structure.

## LANDING

### NORMAL LANDING

Normal landing approaches can be made with power-on or power-off with any flap setting desired. Surface winds and air turbulence are usually the primary factors in determining the most comfortable approach speeds. Steep slips should be avoided with flap settings greater than 20° due to a slight tendency for the elevator to oscillate under certain combinations of airspeed, sideslip angle, and center of gravity loadings.

#### NOTE

Carburetor heat should be applied prior to any significant reduction or closing of the throttle.

Actual touchdown should be made with power-off and on the main wheels first to reduce the landing speed and subsequent need for braking in the landing roll. The nose wheel is lowered to the runway gently after the speed has diminished to avoid unnecessary nose gear loads. This procedure is especially important in rough or soft field landings.

### SHORT FIELD LANDING

For a maximum performance short field landing in smooth air conditions, make an approach at the minimum recommended airspeed with full flaps using enough power to control the glide path. (Slightly higher approach speeds should be used under turbulent air conditions.) After all approach obstacles are cleared, progressively reduce power and main-



tain the approach speed by lowering the nose of the airplane. Touchdown should be made with power off and on the main wheels first. Immediately after touchdown, lower the nose wheel and apply heavy braking as required. For maximum brake effectiveness, retract the flaps, hold the control wheel full back, and apply maximum brake pressure without sliding the tires.

### CROSSWIND LANDING

When landing in a strong crosswind, use the minimum flap setting required for the field length. If flap settings greater than 20° are used in sideslips with full rudder deflection, some elevator oscillation may be felt at normal approach speeds. However, this does not affect control of the airplane. Although the crab or combination method of drift correction may be used, the wing-low method gives the best control. After touchdown, hold a straight course with the steerable nose wheel and occasional braking if necessary.

The maximum allowable crosswind velocity is dependent upon pilot capability as well as aircraft limitations. With average pilot technique, direct crosswinds of 15 knots can be handled with safety.

### BALKED LANDING

In a bailed landing (go-around) climb, reduce the wing flap setting to 20° immediately after full power is applied. If the flaps were extended to 40°, the reduction to 20° may be approximated by placing the flap switch in the UP position for two seconds and then returning the switch to neutral. If obstacles must be cleared during the go-around climb, leave the wing flaps in the 10° to 20° range and maintain a safe airspeed until the obstacles are cleared. Above 3000 feet, lean the mixture to obtain maximum RPM. After clearing any obstacles, the flaps may be retracted as the airplane accelerates to the normal flaps-up climb speed.

## COLD WEATHER OPERATION

### STARTING

Prior to starting on a cold morning, it is advisable to pull the propeller through several times by hand to "break loose" or "limber" the oil, thus conserving battery energy.

### NOTE

When pulling the propeller through by hand, treat it as if the ignition switch is turned on. A loose or broken ground wire on either magneto could cause the engine to fire.

In extremely cold (-18°C and lower) weather, the use of an external pre-heater and an external power source are recommended whenever possible to obtain positive starting and to reduce wear and abuse to the engine and electrical system. Pre-heat will thaw the oil trapped in the oil cooler, which probably will be congealed prior to starting in extremely cold temperatures. When using an external power source, the position of the master switch is important. Refer to Section 7 under Ground Service Plug Receptacle for operating details.

Cold weather starting procedures are as follows:

#### With Preheat:

- (1) With ignition switch OFF and throttle closed, prime the engine four to eight strokes as the propeller is being turned over by hand.

### NOTE

Use heavy strokes of primer for best atomization of fuel. After priming, push primer all the way in and turn to locked position to avoid possibility of engine drawing fuel through the primer.

- (2) Propeller Area -- CLEAR.
- (3) Master Switch -- ON.
- (4) Mixture -- FULL RICH.
- (5) Throttle -- OPEN 1/8 INCH.
- (6) Ignition Switch -- START.
- (7) Release ignition switch to BOTH when engine starts.
- (8) Oil Pressure -- CHECK.

#### Without Preheat:

- (1) Prime the engine six to ten strokes while the propeller is being turned by hand with throttle closed. Leave primer charged and ready for stroke.
- (2) Propeller Area -- CLEAR.
- (3) Master Switch -- ON.
- (4) Mixture -- FULL RICH.

- (5) Ignition Switch -- START.
- (6) Pump throttle rapidly to full open twice. Return to 1/8 inch open position.
- (7) Release ignition switch to BOTH when engine starts.
- (8) Continue to prime engine until it is running smoothly, or alternately pump throttle rapidly over first 1/4 of total travel.
- (9) Oil Pressure -- CHECK.
- (10) Pull carburetor heat knob full on after engine has started. Leave on until engine is running smoothly.
- (11) Lock Primer.

#### NOTE

If the engine does not start during the first few attempts, or if the engine firing diminishes in strength, it is probable that the spark plugs have been frosted over. Pre-heat must be used before another start is attempted.

#### CAUTION

Pumping the throttle may cause raw fuel to accumulate in the intake air duct, creating a fire hazard in the event of a backfire. If this occurs, maintain a cranking action to suck flames into the engine. An outside attendant with a fire extinguisher is advised for cold starts without pre-heat.

During cold weather operations, no indication will be apparent on the oil temperature gage prior to takeoff if outside air temperatures are very cold. After a suitable warm-up period (2 to 5 minutes at 1000 RPM), accelerate the engine several times to higher engine RPM. If the engine accelerates smoothly and the oil pressure remains normal and steady, the airplane is ready for takeoff.

#### FLIGHT OPERATIONS

Takeoff is made normally with carburetor heat off. Avoid excessive leaning in cruise.

Carburetor heat may be used to overcome any occasional engine roughness due to ice.

When operating in temperatures below -18°C, avoid using partial carburetor heat. Partial heat may increase the carburetor air temperature to the 0° to 21°C range, where icing is critical under certain atmospheric conditions.

#### HOT WEATHER OPERATION

Refer to the general warm temperature starting information under Starting Engine in this section. Avoid prolonged engine operation on the ground.

#### NOISE ABATEMENT

Increased emphasis on improving the quality of our environment requires renewed effort on the part of all pilots to minimize the effect of aircraft noise on the public.

We, as pilots, can demonstrate our concern for environmental improvement, by application of the following suggested procedures, and thereby tend to build public support for aviation:

- (1) Pilots operating aircraft under VFR over outdoor assemblies of persons, recreational and park areas, and other noise-sensitive areas should make every effort to fly not less than 2,000 feet above the surface, weather permitting, even though flight at a lower level may be consistent with the provisions of government regulations.
- (2) During departure from or approach to an airport, climb after takeoff and descent for landing should be made so as to avoid prolonged flight at low altitude near noise-sensitive areas.

#### NOTE

The above recommended procedures do not apply where they would conflict with Air Traffic Control clearances or instructions, or where, in the pilot's judgement, an altitude of less than 2,000 feet is necessary for him to adequately exercise his duty to see and avoid other aircraft.

# SECTION 5 PERFORMANCE

## TABLE OF CONTENTS

	Page
Introduction . . . . .	5-3
Use of Performance Charts . . . . .	5-3
Sample Problem . . . . .	5-3
Takeoff . . . . .	5-4
Cruise . . . . .	5-5
Fuel Required . . . . .	5-6
Landing . . . . .	5-7
Figure 5-1, Airspeed Calibration - Normal Static Source . . . . .	5-8
Airspeed Calibration - Alternate Static Source . . . . .	5-9
Figure 5-2, Temperature Conversion Chart . . . . .	5-10
Figure 5-3, Stall Speeds . . . . .	5-11
Figure 5-4, Takeoff Distance - 2300 Lbs . . . . .	5-12
Takeoff Distance - 2100 Lbs and 1900 Lbs . . . . .	5-13
Figure 5-5, Rate of Climb . . . . .	5-14
Figure 5-6, Time, Fuel, and Distance to Climb . . . . .	5-15
Figure 5-7, Cruise Performance . . . . .	5-16
Figure 5-8, Range Profile - 38.0 Gallons Fuel . . . . .	5-17
Range Profile - 48.0 Gallons Fuel . . . . .	5-18
Figure 5-9, Endurance Profile - 38.0 Gallons Fuel . . . . .	5-19
Endurance Profile - 48.0 Gallons Fuel . . . . .	5-20
Figure 5-10, Landing Distance . . . . .	5-21

## INTRODUCTION

Performance data charts on the following pages are presented so that you may know what to expect from the airplane under various conditions, and also, to facilitate the planning of flights in detail and with reasonable accuracy. The data in the charts has been computed from actual flight tests with the airplane and engine in good condition and using average piloting techniques.

It should be noted that the performance information presented in the range and endurance profile charts allows for 45 minutes reserve fuel based on 45% power. Fuel flow data for cruise is based on the recommended lean mixture setting. Some indeterminate variables such as mixture leaning technique, fuel metering characteristics, engine and propeller condition, and air turbulence may account for variations of 10% or more in range and endurance. Therefore, it is important to utilize all available information to estimate the fuel required for the particular flight.

## USE OF PERFORMANCE CHARTS

Performance data is presented in tabular or graphical form to illustrate the effect of different variables. Sufficiently detailed information is provided in the tables so that conservative values can be selected and used to determine the particular performance figure with reasonable accuracy.

## SAMPLE PROBLEM

The following sample flight problem utilizes information from the various charts to determine the predicted performance data for a typical flight. The following information is known:

### AIRPLANE CONFIGURATION

Takeoff weight	2250 Pounds
Usable fuel	38 Gallons

### TAKEOFF CONDITIONS

Field pressure altitude	1500 Feet
Temperature	28°C (16°C above standard)
Wind component along runway	12 Knot Headwind
Field length	3500 Feet

## CRUISE CONDITIONS

Total distance	420 Nautical Miles
Pressure altitude	5500 Feet
Temperature	20°C (16°C above standard)
Expected wind enroute	10 Knot Headwind

## LANDING CONDITIONS

Field pressure altitude	2000 Feet
Temperature	25°C
Wind component along runway	6 Knot Headwind
Field length	3000 Feet

## TAKEOFF

The takeoff distance chart, figure 5-4, should be consulted, keeping in mind that the distances shown are based on maximum performance techniques. Conservative distances can be established by reading the chart at the next higher value of weight, altitude and temperature. For example, in this particular sample problem, the takeoff distance information presented for a weight of 2300 lbs., a pressure altitude of 2000 feet and a temperature of 30°C should be used and results in the following:

Ground roll	1155 Feet
Total distance to clear a 50-foot obstacle	2030 Feet

A correction for the effect of wind may be made based on Note 3 of the takeoff chart. The distance correction for a 12 knot headwind is:

$$\frac{12 \text{ Knots}}{9 \text{ Knots}} \times 10\% = 13\% \text{ Decrease}$$

This results in the following distances, corrected for wind:

Ground roll, zero wind	1155
Decrease in ground roll (1155 feet x 13%)	<u>150</u>
Corrected ground roll	1005 Feet
Total distance to clear a 50-foot obstacle, zero wind	2030
Decrease in total distance (2030 feet x 13%)	<u>264</u>
Corrected total distance to clear 50-foot obstacle	1766 Feet

These distances are well within the takeoff field length quoted earlier for

the sample problem.

## CRUISE

The cruising altitude and winds aloft information have been given for this flight. However, the power setting selection for cruise must be determined based on several considerations. These include the cruise performance characteristics of the airplane presented in figure 5-7, the range profile chart presented in figure 5-8, and the endurance profile chart presented in figure 5-9.

The range profile chart illustrates the relationship between power and range. Considerable fuel savings and longer range result when lower power settings are used.

For this sample problem with a cruise altitude of 5500 feet and distance of 420 nautical miles, the range profile chart indicates that use of a 75% power setting will necessitate a fuel stop, in view of the anticipated 10 knot headwind component. However, selecting a 65% power setting from the range profile chart yields a predicted range of 477 nautical miles under zero wind conditions. The endurance profile chart, figure 5-9, shows a corresponding 4.4 hours.

The range figure of 477 nautical miles is corrected to account for the expected 10 knot headwind at 5500 feet.

Range, zero wind	477
Decrease in range due to wind (4.4 hours x 10 knot headwind)	<u>44</u>
Corrected range	433 Nautical Miles

This indicates that the trip can be made without a fuel stop using approximately 65% power.

The cruise performance chart, figure 5-7, is entered at 6000 feet altitude and 20°C above standard temperature. These values most nearly correspond to the expected altitude and temperature conditions. The engine speed chosen is 2500 RPM, which results in the following:

Power	62%
True airspeed	109 Knots
Cruise fuel flow	7.0 GPH

The power computer may be used to determine power and fuel consumption during the flight.

**FUEL REQUIRED**

The total fuel requirement for the flight may be estimated using the performance information in figures 5-6 and 5-7. For this sample problem, figure 5-6 shows that a climb from 1000 feet to 6000 feet requires 2.0 gallons of fuel and may be used as a conservative estimate for this problem. This is for a standard temperature (as shown on the climb chart). The approximate effect of a non-standard temperature is to increase the time, fuel, and distance by 10% for each 10°C above standard temperature, due to the lower rate of climb. In this case, assuming a temperature 16°C above standard, the correction would be:

$$\frac{16^{\circ}\text{C}}{10^{\circ}\text{C}} \times 10\% = 16\% \text{ Increase}$$

With this factor included, the fuel estimate would be calculated as follows:

Fuel to climb, standard temperature	2.0
Increase due to non-standard temperature (2.0 x 16%)	0.3
Corrected fuel to climb	<u>2.3</u> Gallons

In addition, the distance to climb, as given in figure 5-6, may be corrected for non-standard temperature as follows:

Distance to climb, standard temperature	14
Increase due to non-standard temperature (14 nautical miles x 16%)	2
Corrected distance to climb	<u>16</u> Nautical Miles

The resultant cruise distance is:

Total distance	420
Climb distance	-16
Cruise distance	<u>404</u> Nautical Miles

With an expected 10 knot headwind, the ground speed for cruise is predicted to be:

$$\begin{array}{r} 109 \\ -10 \\ \hline 99 \text{ Knots} \end{array}$$

Therefore, the time required for the cruise portion of the trip is:

$$\frac{404 \text{ Nautical Miles}}{99 \text{ Knots}} = 4.1 \text{ Hours}$$

The fuel required for cruise is endurance times fuel consumption:

$$4.1 \text{ hours} \times 7.0 \text{ gallons/hour} = 28.7 \text{ Gallons}$$

The total estimated fuel required is as follows:

Engine start, taxi, and takeoff	1.1
Climb	2.3
Cruise	28.7
Total fuel required	<u>32.1</u> Gallons

This will leave a fuel reserve of:

$$\begin{array}{r} 38.0 \\ -32.1 \\ \hline 5.9 \text{ Gallons} \end{array}$$

Once the flight is underway, ground speed checks will provide a more accurate basis for estimating the time enroute and the corresponding fuel required to complete the trip with ample reserve.

**LANDING**

A procedure similar to the takeoff calculations should be used for estimating the landing distance at the destination airport. Figure 5-10 presents maximum performance technique landing distances for various airport altitude and temperature combinations. The distances corresponding to 2000 feet altitude and 30°C should be used and result in the following:

Ground roll	590 Feet
Total distance to clear a 50-foot obstacle	1370 Feet

A correction for wind may be made based on Note 2 of the landing chart. The distance correction for a 6 knot headwind is:

$$\frac{6 \text{ Knots}}{9 \text{ Knots}} \times 10\% = 7\% \text{ Decrease}$$

This results in the following wind-corrected figures:

Ground roll	549 Feet
Total distance over a 50-foot obstacle	1274 Feet

These distances are well within the landing field length quoted previously for this sample problem.

**AIRSPED CALIBRATION**  
NORMAL STATIC SOURCE

FLAPS UP												
KIAS	40	50	60	70	80	90	100	110	120	130	140	
KCAS	49	55	62	70	80	89	99	108	118	128	138	
FLAPS 10°												
KIAS	40	50	60	70	80	85	---	---	---	---	---	
KCAS	49	55	62	71	80	85	---	---	---	---	---	
FLAPS 40°												
KIAS	40	50	60	70	80	85	---	---	---	---	---	
KCAS	47	54	62	71	81	86	---	---	---	---	---	

Figure 5-1. Airspeed Calibration (Sheet 1 of 2)

**AIRSPED CALIBRATION**  
ALTERNATE STATIC SOURCE

HEATER/VENTS AND WINDOWS CLOSED

FLAPS UP												
NORMAL KIAS	40	50	60	70	80	90	100	110	120	130	140	
ALTERNATE KIAS	39	51	61	71	82	91	101	111	121	131	141	
FLAPS 10°												
NORMAL KIAS	40	50	60	70	80	85	---	---	---	---	---	
ALTERNATE KIAS	40	51	61	71	81	85	---	---	---	---	---	
FLAPS 40°												
NORMAL KIAS	40	50	60	70	80	85	---	---	---	---	---	
ALTERNATE KIAS	38	50	60	70	79	83	---	---	---	---	---	

HEATER/VENTS OPEN AND WINDOWS CLOSED

FLAPS UP												
NORMAL KIAS	40	50	60	70	80	90	100	110	120	130	140	
ALTERNATE KIAS	36	48	59	70	80	89	99	108	118	128	139	
FLAPS 10°												
NORMAL KIAS	40	50	60	70	80	85	---	---	---	---	---	
ALTERNATE KIAS	38	49	59	69	79	84	---	---	---	---	---	
FLAPS 40°												
NORMAL KIAS	40	50	60	70	80	85	---	---	---	---	---	
ALTERNATE KIAS	34	47	57	67	77	81	---	---	---	---	---	

WINDOWS OPEN

FLAPS UP												
NORMAL KIAS	40	50	60	70	80	90	100	110	120	130	140	
ALTERNATE KIAS	26	43	57	70	82	93	103	113	123	133	143	
FLAPS 10°												
NORMAL KIAS	40	50	60	70	80	85	---	---	---	---	---	
ALTERNATE KIAS	25	43	57	69	80	85	---	---	---	---	---	
FLAPS 40°												
NORMAL KIAS	40	50	60	70	80	85	---	---	---	---	---	
ALTERNATE KIAS	25	41	54	67	78	84	---	---	---	---	---	

Figure 5-1. Airspeed Calibration (Sheet 2 of 2)

TEMPERATURE CONVERSION CHART

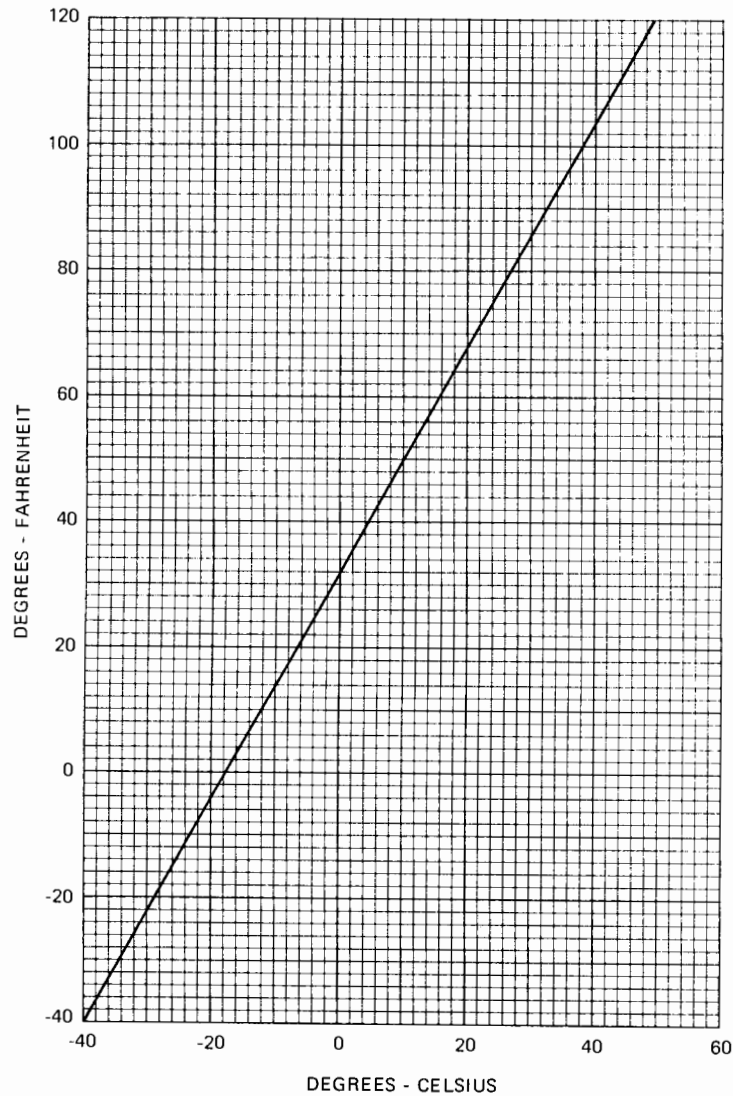

Figure 5-2. Temperature Conversion Chart

STALL SPEEDS

CONDITIONS:  
Power Off

NOTES:

1. Maximum altitude loss during a stall recovery is approximately 180 feet.
2. KIAS values are approximate.

MOST REARWARD CENTER OF GRAVITY

WEIGHT LBS	FLAP DEFLECTION	ANGLE OF BANK							
		0°		30°		45°		60°	
		KIAS	KCAS	KIAS	KCAS	KIAS	KCAS	KIAS	KCAS
2300	UP	42	50	45	54	50	59	59	71
	10°	38	47	40	51	45	56	54	66
	40°	36	44	38	47	43	52	51	62

MOST FORWARD CENTER OF GRAVITY

WEIGHT LBS	FLAP DEFLECTION	ANGLE OF BANK							
		0°		30°		45°		60°	
		KIAS	KCAS	KIAS	KCAS	KIAS	KCAS	KIAS	KCAS
2300	UP	47	53	51	57	56	63	66	75
	10°	44	51	47	55	52	61	62	72
	40°	41	47	44	51	49	56	58	66

Figure 5-3. Stall Speeds



**TAKEOFF DISTANCE  
MAXIMUM WEIGHT 2300 LBS**

**CONDITIONS:**

- Flaps Up
- Full Throttle Prior to Brake Release
- Paved, Level, Dry Runway
- Zero Wind

**NOTES:**

1. Maximum performance technique as specified in Section 4.
2. Prior to takeoff from fields above 3000 feet elevation, the mixture should be leaned to give maximum RPM in a full throttle, static runup.
3. Decrease distances 10% for each 9 knots headwind. For operation with tailwinds up to 10 knots, increase distances by 10% for each 2 knots.
4. Where distance value has been deleted, climb performance after lift-off is less than 150 fpm at takeoff speed.
5. For operation on a dry, grass runway, increase distances by 15% of the "ground roll" figure.

WEIGHT LBS	TAKEOFF SPEED KIAS		PRESS ALT FT	0°C			10°C			20°C			30°C			40°C						
	LIFT OFF	AT 50 FT		TOTAL TO CLEAR 50 FT OBS			TOTAL TO CLEAR 50 FT OBS			TOTAL TO CLEAR 50 FT OBS			TOTAL TO CLEAR 50 FT OBS			TOTAL TO CLEAR 50 FT OBS						
				GRND ROLL	GRND ROLL	GRND ROLL	GRND ROLL	GRND ROLL	GRND ROLL	GRND ROLL	GRND ROLL	GRND ROLL	GRND ROLL	GRND ROLL	GRND ROLL	GRND ROLL	GRND ROLL	GRND ROLL	GRND ROLL	GRND ROLL		
2300	52	59	S.L.	775	1380	1475	835	895	1575	960	1685	1030	1795	1030	1795	1030	1795	1030	1795			
			1000	850	1510	915	980	1725	1050	1845	1125	1970	1125	1970	1125	1970	1125	1970	1125	1970		
			2000	930	1650	1000	1075	1895	1155	2030	1235	2170	1235	2170	1235	2170	1235	2170	1235	2170	1235	2170
			3000	1020	1815	1100	1180	2085	1270	2235	1360	2395	1360	2395	1360	2395	1360	2395	1360	2395	1360	2395
			4000	1125	2000	1210	1300	2305	1395	2475	1495	2655	1495	2655	1495	2655	1495	2655	1495	2655	1495	2655
			5000	1235	2210	1330	1430	2555	1540	2750	1650	2960	1650	2960	1650	2960	1650	2960	1650	2960	1650	2960
			6000	1365	2450	2640	1470	1580	2850	1700	3070	---	---	---	---	---	---	---	---	---	---	
			7000	1505	2730	2955	1625	1750	---	---	---	---	---	---	---	---	---	---	---	---	---	---
			8000	1665	3065	3320	1800	---	---	---	---	---	---	---	---	---	---	---	---	---	---	---

Figure 5-4. Takeoff Distance (Sheet 1 of 2)

**TAKEOFF DISTANCE  
2100 LBS AND 1900 LBS**

REFER TO SHEET 1 FOR APPROPRIATE CONDITIONS AND NOTES.

WEIGHT LBS	TAKEOFF SPEED KIAS		PRESS ALT FT	0°C			10°C			20°C			30°C			40°C							
	LIFT OFF	AT 50 FT		TOTAL TO CLEAR 50 FT OBS			TOTAL TO CLEAR 50 FT OBS			TOTAL TO CLEAR 50 FT OBS			TOTAL TO CLEAR 50 FT OBS			TOTAL TO CLEAR 50 FT OBS							
				GRND ROLL	GRND ROLL	GRND ROLL	GRND ROLL	GRND ROLL	GRND ROLL	GRND ROLL	GRND ROLL	GRND ROLL	GRND ROLL	GRND ROLL	GRND ROLL	GRND ROLL	GRND ROLL	GRND ROLL	GRND ROLL	GRND ROLL	GRND ROLL		
2100	50	56	S.L.	630	1130	1210	680	725	1290	780	1375	835	1465	780	1375	835	1465	780	1375	835	1465		
			1000	690	1235	1320	740	795	1405	855	1500	915	1600	855	1500	915	1600	855	1500	915	1600		
			2000	755	1350	1440	810	870	1540	935	1645	1000	1755	1000	1755	1000	1755	1000	1755	1000	1755	1000	1755
			3000	830	1475	1580	890	955	1690	1025	1805	1100	1930	1100	1930	1100	1930	1100	1930	1100	1930	1100	1930
			4000	910	1620	1735	980	1050	1860	1125	1990	1210	2130	1210	2130	1210	2130	1210	2130	1210	2130	1210	2130
			5000	1000	1780	1910	1075	1155	2050	1240	2195	1330	2355	1330	2355	1330	2355	1330	2355	1330	2355	1330	2355
1900	47	54	6000	1100	1965	2115	1185	1275	2270	1370	2435	1465	2615	1370	2435	1465	2615	1370	2435	1465	2615		
			7000	1215	2180	2345	1305	1405	2520	1510	2715	1620	2920	1620	2920	1620	2920	1620	2920	1620	2920		
			8000	1340	2425	2615	1445	1555	2815	1675	3040	1795	3280	1795	3280	1795	3280	1795	3280	1795	3280		
			S.L.	505	915	975	540	580	1035	620	1105	665	1175	665	1175	665	1175	665	1175	665	1175	665	1175
			1000	550	995	1060	590	635	1130	680	1205	725	1280	725	1280	725	1280	725	1280	725	1280	725	1280
			2000	600	1085	1155	645	695	1230	745	1315	795	1400	795	1400	795	1400	795	1400	795	1400	795	1400
			3000	660	1180	1260	710	760	1345	815	1435	870	1530	870	1530	870	1530	870	1530	870	1530		
			4000	725	1290	1380	775	835	1475	895	1575	955	1680	955	1680	955	1680	955	1680	955	1680		
			5000	795	1415	1515	855	915	1620	985	1735	1055	1850	1055	1850	1055	1850	1055	1850	1055	1850		
			6000	870	1555	1670	940	1010	1785	1080	1910	1160	2045	1160	2045	1160	2045	1160	2045	1160	2045		
			7000	960	1715	1840	1035	1110	1975	1195	2115	1280	2265	1280	2265	1280	2265	1280	2265	1280	2265		
			8000	1060	1900	2040	1140	1225	2190	1320	2350	1415	2520	1415	2520	1415	2520	1415	2520	1415	2520		

Figure 5-4. Takeoff Distance (Sheet 2 of 2)

**RATE OF CLIMB**

CONDITIONS:

Flaps Up  
Full Throttle  
Mixture Leaned for Maximum RPM During Climb

WEIGHT LBS	PRESS ALT FT	CLIMB SPEED KIAS	RATE OF CLIMB - FPM			
			-20°C	0°C	20°C	40°C
			2300	S.L.	78	755
	2000	76	655	595	535	470
	4000	74	555	500	440	380
	6000	72	460	405	350	290
	8000	70	365	310	255	200
	10,000	68	270	215	165	---
	12,000	66	175	125	---	---

Figure 5-5. Rate of Climb

**TIME, FUEL, AND DISTANCE TO CLIMB**

CONDITIONS:

Flaps Up  
Full Throttle  
Standard Temperature

NOTES:

1. Add 1.1 gallons of fuel for engine start, taxi and takeoff allowance.
2. To obtain maximum rate of climb as shown in this chart, lean to maximum RPM during climb.
3. Increase time, fuel and distance by 10% for each 10°C above standard temperature.
4. Distances shown are based on zero wind.

WEIGHT LBS	PRESSURE ALTITUDE FT	TEMP °C	CLIMB SPEED KIAS	RATE OF CLIMB FPM	FROM SEA LEVEL		
					TIME MIN	FUEL USED GALLONS	DISTANCE NM
2300	S.L.	15	78	645	0	0.0	0
	1000	13	77	605	2	0.3	2
	2000	11	76	560	3	0.7	4
	3000	9	75	520	5	1.1	7
	4000	7	74	480	7	1.5	9
	5000	5	73	435	9	1.9	12
	6000	3	72	395	12	2.3	16
	7000	1	71	355	15	2.8	19
	8000	-1	70	315	18	3.3	23
	9000	-3	69	270	21	3.9	28
	10,000	-5	68	230	25	4.5	33
	11,000	-7	67	185	30	5.2	40
	12,000	-9	66	145	36	6.1	48

Figure 5-6. Time, Fuel, and Distance to Climb

**CRUISE PERFORMANCE**

CONDITIONS:  
Recommended Lean Mixture  
2300 Pounds

PRESSURE ALTITUDE	RPM	20°C BELOW STANDARD TEMP			STANDARD TEMPERATURE			20°C ABOVE STANDARD TEMP		
		% BHP	KTAS	GPH	% BHP	KTAS	GPH	% BHP	KTAS	GPH
2000	2550	80	114	8.8	75	113	8.2	71	113	7.8
	2500	76	111	8.3	71	111	7.8	67	111	7.5
	2400	68	107	7.5	64	107	7.2	61	106	6.9
	2300	61	102	6.9	58	101	6.7	55	99	6.5
	2200	55	96	6.4	52	95	6.2	49	93	6.1
4000	2600	80	116	8.8	75	116	8.3	71	116	7.8
	2500	72	111	7.9	68	111	7.5	64	110	7.2
	2400	65	107	7.3	61	106	6.9	58	104	6.7
	2300	58	101	6.7	55	100	6.5	53	98	6.3
	2200	52	95	6.3	49	93	6.1	47	92	5.9
6000	2650	80	118	8.8	75	118	8.2	71	118	7.8
	2600	76	116	8.3	71	116	7.9	68	115	7.5
	2500	69	111	7.6	65	110	7.2	62	109	7.0
	2400	62	106	7.0	59	104	6.7	56	103	6.5
	2300	56	100	6.5	53	98	6.3	50	97	6.1
8000	2200	50	94	6.1	47	92	5.9	45	91	5.8
	2700	80	120	8.8	75	120	8.3	71	120	7.8
	2600	72	116	8.0	68	115	7.5	65	114	7.3
	2500	65	111	7.3	62	109	7.0	59	108	6.8
	2400	59	105	6.8	56	103	6.6	53	101	6.3
10,000	2300	54	99	6.4	51	97	6.2	48	96	6.0
	2200	48	93	6.0	45	91	5.8	43	90	5.7
	2700	76	120	8.4	72	120	7.9	68	119	7.6
	2600	69	115	7.6	65	114	7.3	62	112	7.0
	2500	63	110	7.1	59	108	6.8	56	106	6.6
12,000	2400	57	104	6.6	54	102	6.4	51	100	6.2
	2300	51	97	6.2	48	96	6.0	46	95	5.8
	2200	46	92	5.8	43	90	5.7	41	89	5.5
	2650	69	117	7.6	65	116	7.3	62	114	7.0
	2600	66	114	7.4	62	113	7.0	59	111	6.8
12,000	2500	60	108	6.8	57	106	6.6	54	105	6.4
	2400	54	102	6.4	51	100	6.2	49	99	6.0
	2300	49	96	6.0	46	95	5.9	43	94	5.7
	2200	44	91	5.7	41	89	5.5	38	88	5.3

Figure 5-7. Cruise Performance

**RANGE PROFILE**  
45 MINUTES RESERVE  
38.0 GALLONS USABLE FUEL

CONDITIONS:  
2300 Pounds  
Recommended Lean Mixture for Cruise  
Standard Temperature  
Zero Wind

NOTES:

1. This chart allows for the fuel used for engine start, taxi, takeoff and climb, and the distance during climb as shown in figure 5-6.
2. Reserve fuel is based on 45 minutes at 45% BHP and is 4.3 gallons.

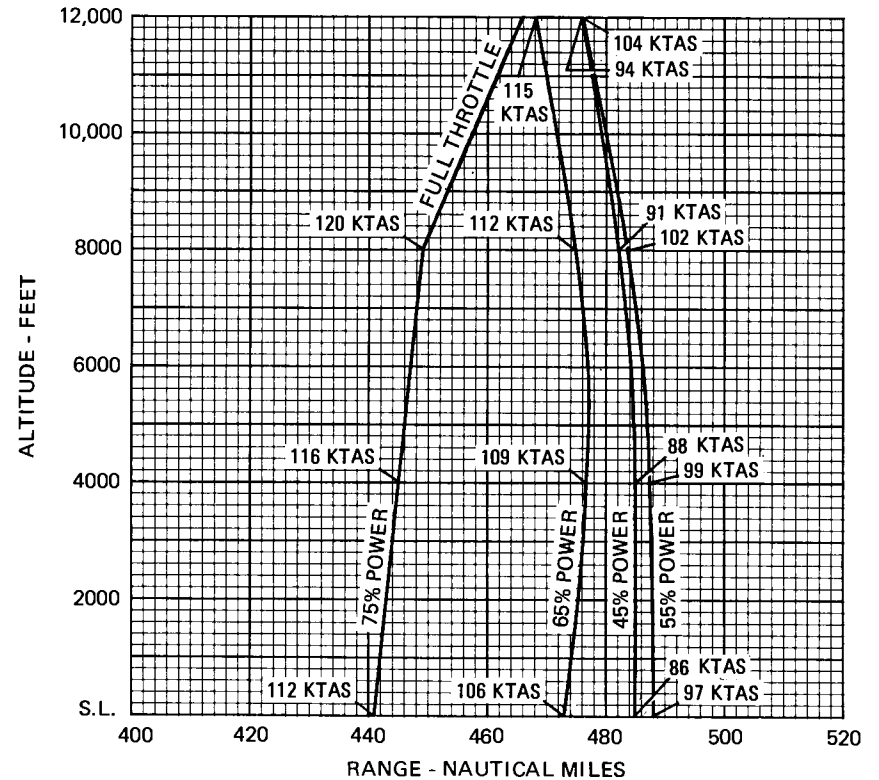

Figure 5-8. Range Profile (Sheet 1 of 2)

**RANGE PROFILE**  
45 MINUTES RESERVE  
48.0 GALLONS USABLE FUEL

CONDITIONS:  
2300 Pounds  
Recommended Lean Mixture for Cruise  
Standard Temperature  
Zero Wind

- NOTES:
1. This chart allows for the fuel used for engine start, taxi, takeoff and climb, and the distance during climb as shown in figure 5-6.
  2. Reserve fuel is based on 45 minutes at 45% BHP and is 4.3 gallons.

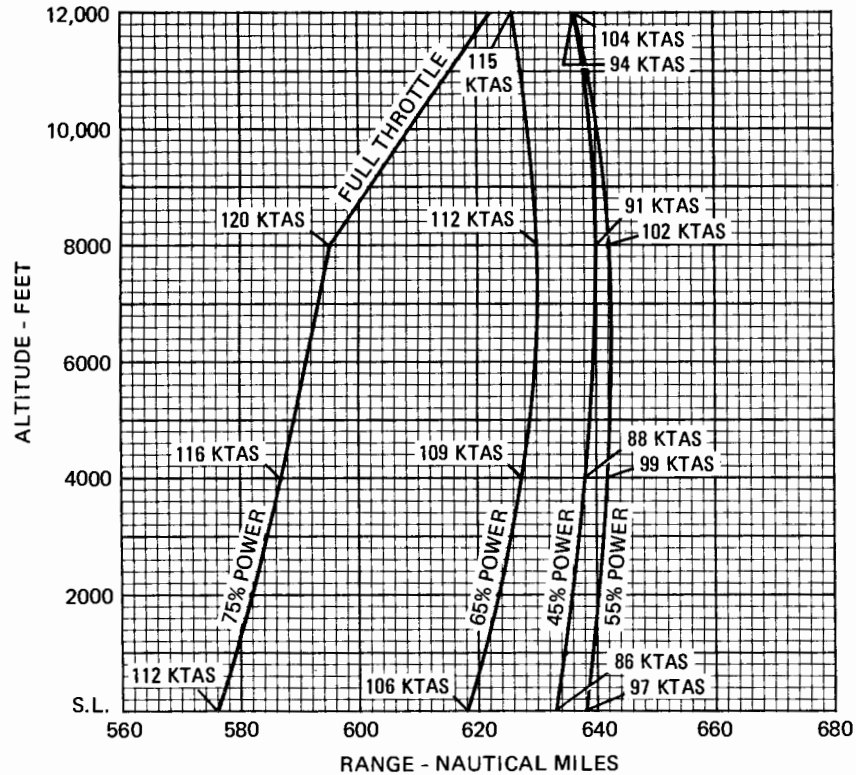

Figure 5-8. Range Profile (Sheet 2 of 2)

**ENDURANCE PROFILE**  
45 MINUTES RESERVE  
38.0 GALLONS USABLE FUEL

CONDITIONS:  
2300 Pounds  
Recommended Lean Mixture for Cruise  
Standard Temperature

- NOTES:
1. This chart allows for the fuel used for engine start, taxi, takeoff and climb, and the time during climb as shown in figure 5-6.
  2. Reserve fuel is based on 45 minutes at 45% BHP and is 4.3 gallons.

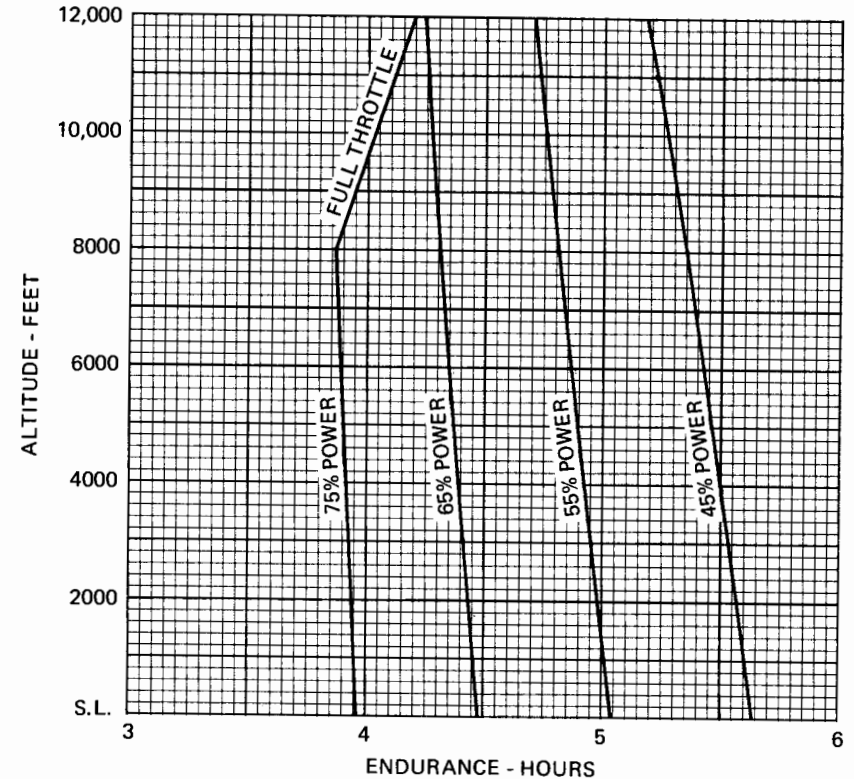

Figure 5-9. Endurance Profile (Sheet 1 of 2)

**ENDURANCE PROFILE**  
45 MINUTES RESERVE  
48.0 GALLONS USABLE FUEL

CONDITIONS:  
2300 Pounds  
Recommended Lean Mixture for Cruise  
Standard Temperature

- NOTES:
1. This chart allows for the fuel used for engine start, taxi, takeoff and climb, and the time during climb as shown in figure 5-6.
  2. Reserve fuel is based on 45 minutes at 45% BHP and is 4.3 gallons.

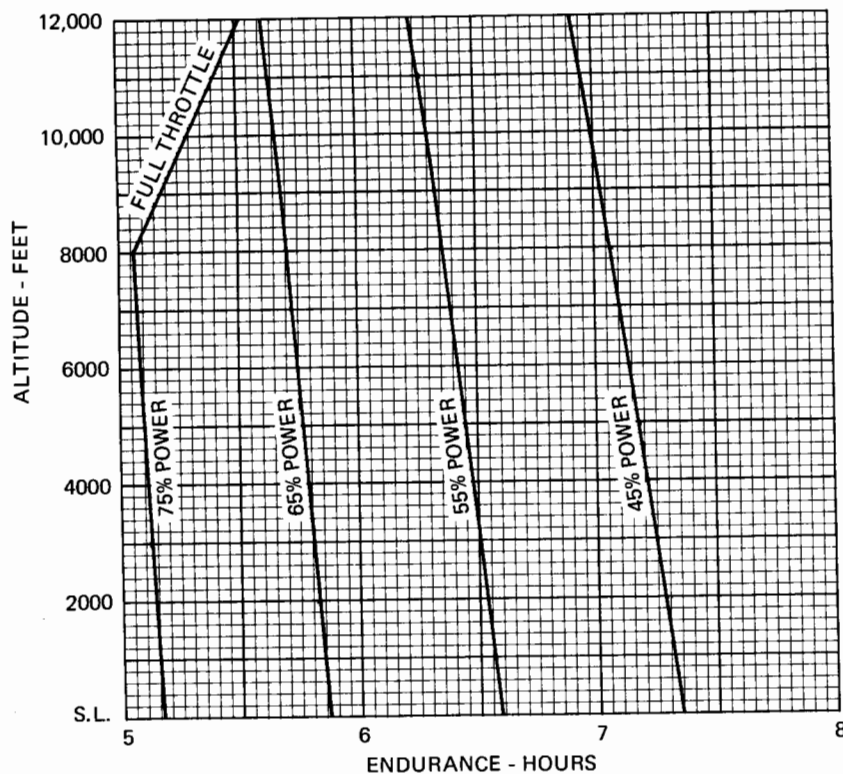

Figure 5-9. Endurance Profile (Sheet 2 of 2)

**LANDING DISTANCE**

CONDITIONS:  
Flaps 40°  
Power Off  
Maximum Braking  
Paved, Level, Dry Runway  
Zero Wind

- NOTES:
1. Maximum performance technique as specified in Section 4.
  2. Decrease distances 10% for each 9 knots headwind. For operation with tailwinds up to 10 knots, increase distances by 10% for each 2 knots.
  3. For operation on a dry, grass runway, increase distances by 45% of the "ground roll" figure.

WEIGHT LBS	SPEED AT 50 FT KIAS	PRESS ALT FT	0°C		10°C		20°C		30°C		40°C	
			GRND ROLL	TOTAL TO CLEAR 50 FT OBS	GRND ROLL	TOTAL TO CLEAR 50 FT OBS	GRND ROLL	TOTAL TO CLEAR 50 FT OBS	GRND ROLL	TOTAL TO CLEAR 50 FT OBS	GRND ROLL	TOTAL TO CLEAR 50 FT OBS
2300	60	S.L.	495	1205	510	1235	530	1265	545	1295	565	1330
		1000	510	1235	550	1300	570	1335	590	1370	610	1405
		2000	530	1265	570	1335	590	1370	610	1405	630	1440
		3000	550	1300	590	1370	615	1410	635	1445	655	1480
		4000	570	1335	615	1415	635	1450	655	1485	680	1525
		5000	590	1370	640	1455	660	1490	685	1535	705	1570
		6000	615	1415	660	1495	685	1535	710	1575	730	1615
		8000	665	1500	690	1540	710	1580	735	1620	760	1665

Figure 5-10. Landing Distance

# SECTION 6 WEIGHT & BALANCE/ EQUIPMENT LIST

## TABLE OF CONTENTS

	Page
Introduction . . . . .	6-3
Airplane Weighing Procedures . . . . .	6-3
Weight and Balance . . . . .	6-5
Equipment List . . . . .	6-13

## INTRODUCTION

This section describes the procedure for establishing the basic empty weight and moment of the airplane. Sample forms are provided for reference. Procedures for calculating the weight and moment for various operations are also provided. A comprehensive list of all Cessna equipment available for this airplane is included at the back of this section.

It should be noted that specific information regarding the weight, arm, moment and installed equipment list for this airplane can only be found in the appropriate weight and balance records carried in the airplane.

## AIRPLANE WEIGHING PROCEDURES

- (1) Preparation:
  - a. Inflate tires to recommended operating pressures.
  - b. Remove the fuel tank sump quick-drain fittings and fuel selector valve drain plug to drain all fuel.
  - c. Remove oil sump drain plug to drain all oil.
  - d. Move sliding seats to the most forward position.
  - e. Raise flaps to the fully retracted position.
  - f. Place all control surfaces in neutral position.
- (2) Leveling:
  - a. Place scales under each wheel (minimum scale capacity, 500 pounds nose, 1000 pounds each main).
  - b. Deflate the nose tire and/or lower or raise the nose strut to properly center the bubble in the level (see Figure 6-1).
- (3) Weighing:
  - a. With the airplane level and brakes released, record the weight shown on each scale. Deduct the tare, if any, from each reading.
- (4) Measuring:
  - a. Obtain measurement A by measuring horizontally (along the airplane center line) from a line stretched between the main wheel centers to a plumb bob dropped from the firewall.
  - b. Obtain measurement B by measuring horizontally and parallel to the airplane center line, from center of nose wheel axle, left side, to a plumb bob dropped from the line between the main wheel centers. Repeat on right side and average the measurements.

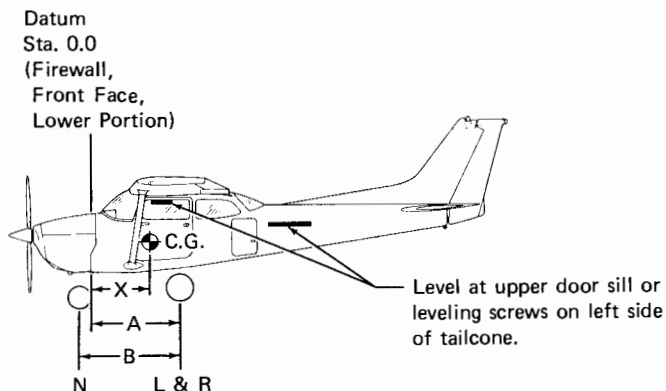

- (5) Using weights from (3) and measurements from (4) the airplane weight and C.G. can be determined.
- (6) Basic Empty Weight may be determined by completing Figure 6-1.

## WEIGHT AND BALANCE

The following information will enable you to operate your Cessna within the prescribed weight and center of gravity limitations. To figure weight and balance, use the Sample Problem, Loading Graph, and Center of Gravity Moment Envelope as follows:

Take the basic empty weight and moment from appropriate weight and balance records carried in your airplane, and enter them in the column titled YOUR AIRPLANE on the Sample Loading Problem.

### NOTE

In addition to the basic empty weight and moment noted on these records, the c.g. arm (fuselage station) is also shown, but need not be used on the Sample Loading Problem. The moment which is shown must be divided by 1000 and this value used as the moment/1000 on the loading problem.

Use the Loading Graph to determine the moment/1000 for each additional item to be carried; then list these on the loading problem.

### NOTE

Loading Graph information for the pilot, passengers, and baggage is based on seats positioned for average occupants and baggage loaded in the center of the baggage areas as shown on the Loading Arrangements diagram. For loadings which may differ from these, the Sample Loading Problem lists fuselage stations for these items to indicate their forward and aft c.g. range limitations (seat travel and baggage area limitation.). Additional moment calculations, based on the actual weight and c.g. arm (fuselage station) of the item being loaded, must be made if the position of the load is different from that shown on the Loading Graph.

Scale Position	Scale Reading	Tare	Symbol	Net Weight
Left Wheel			L	
Right Wheel			R	
Nose Wheel			N	
Sum of Net Weights (As Weighed)			W	

$$X = \text{ARM} = \frac{(A) - (N) \times (B)}{W}; X = ( \quad ) - ( \quad ) \times ( \quad ) = ( \quad ) \text{ IN.}$$

Item	Weight (Lbs.)	X C.G. Arm (In.)	Moment/1000 (Lbs.-In.)
Airplane Weight (From Item 5, page 6-5)			
Add Oil:			
No Oil Filter (8 Qts at 7.5 Lbs/Gal)		-14.0	
With Oil Filter (9 Qts at 7.5 Lbs/Gal)		-14.0	
Add Unusable Fuel:			
Std. Tanks (4 Gal at 6 Lbs/Gal)		46.0	
L.R. Tanks (4 Gal at 6 Lbs/Gal)		46.0	
Equipment Changes			
Airplane Basic Empty Weight			

Figure 6-1. Sample Airplane Weighing





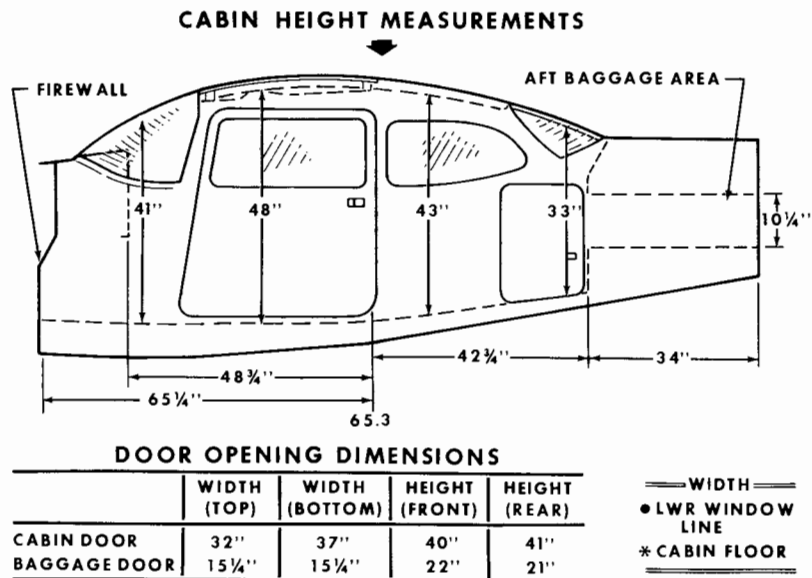

Figure 6-4. Internal Cabin Dimensions

SAMPLE AIRPLANE	YOUR AIRPLANE	
	Weight (lbs.)	Moment (lb.-ins./1000)
<p style="text-align: center;"><b>SAMPLE LOADING PROBLEM</b></p> <p>1. Basic Empty Weight (Use the data pertaining to your airplane as it is presently equipped. Includes unusable fuel and full oil) . . . . .</p> <p>2. Usable Fuel (At 6 Lbs./Gal.) Standard Tanks (38 Gal. Maximum) . . . . .</p> <p>Long Range Tanks (48 Gal. Maximum) . . . . .</p> <p>3. Pilot and Front Passenger (Station 34 to 46) . . . . .</p> <p>4. Rear Passengers . . . . .</p> <p>5. * Baggage Area 1 or Passenger on Child's Seat (Station 82 to 108) 120 Lbs. Max. . . . .</p> <p>6. * Baggage Area 2 (Station 108 to 142) 50 Lbs. Max. . . . .</p> <p>7. TOTAL WEIGHT AND MOMENT</p> <p>8. Locate this point (2300 at 102.9) on the Center of Gravity Moment Envelope, and since this point falls within the envelope, the loading is acceptable.</p> <p style="text-align: center;"><b>NOTE</b></p> <p>* The maximum allowable combined weight capacity for baggage areas 1 and 2 is 120 lbs.</p>	1392	54.6
	228	10.9
	340	12.6
	340	24.8
	2300	102.9

Figure 6-5. Sample Loading Problem

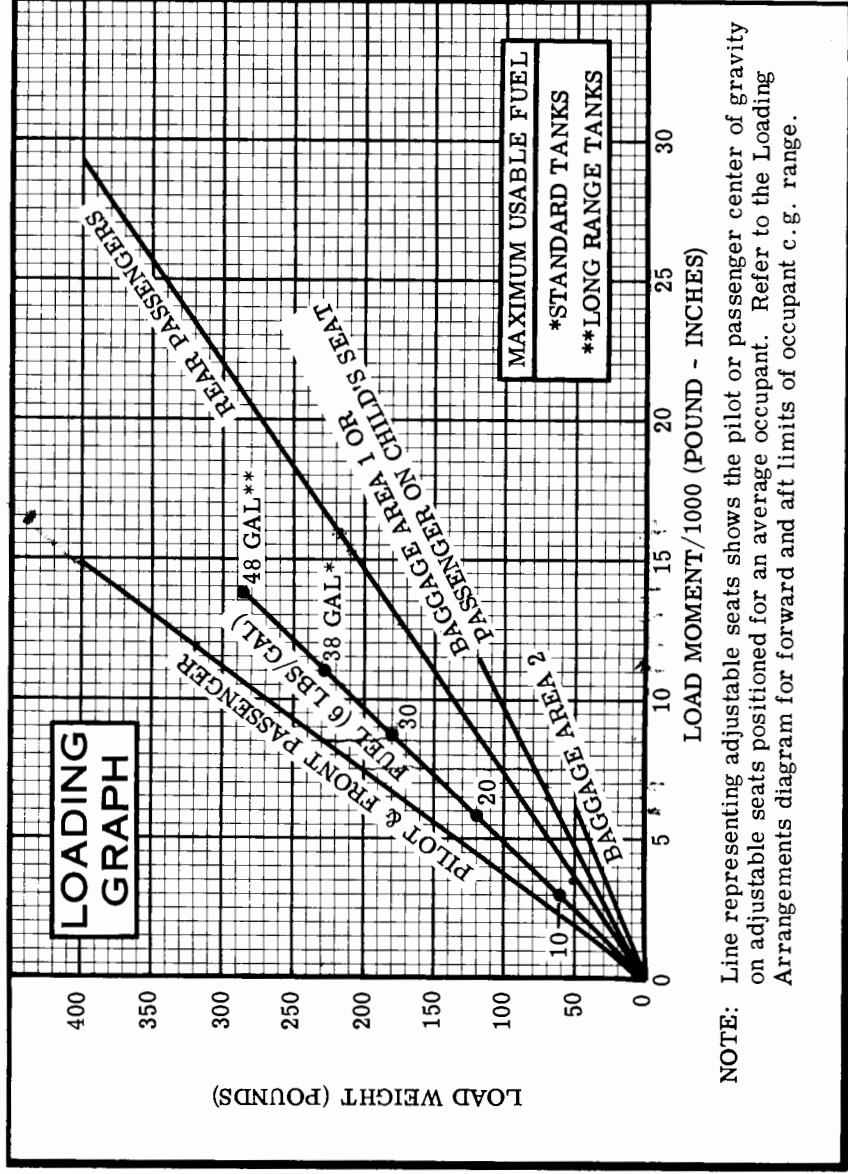

Figure 6-6. Loading Graph

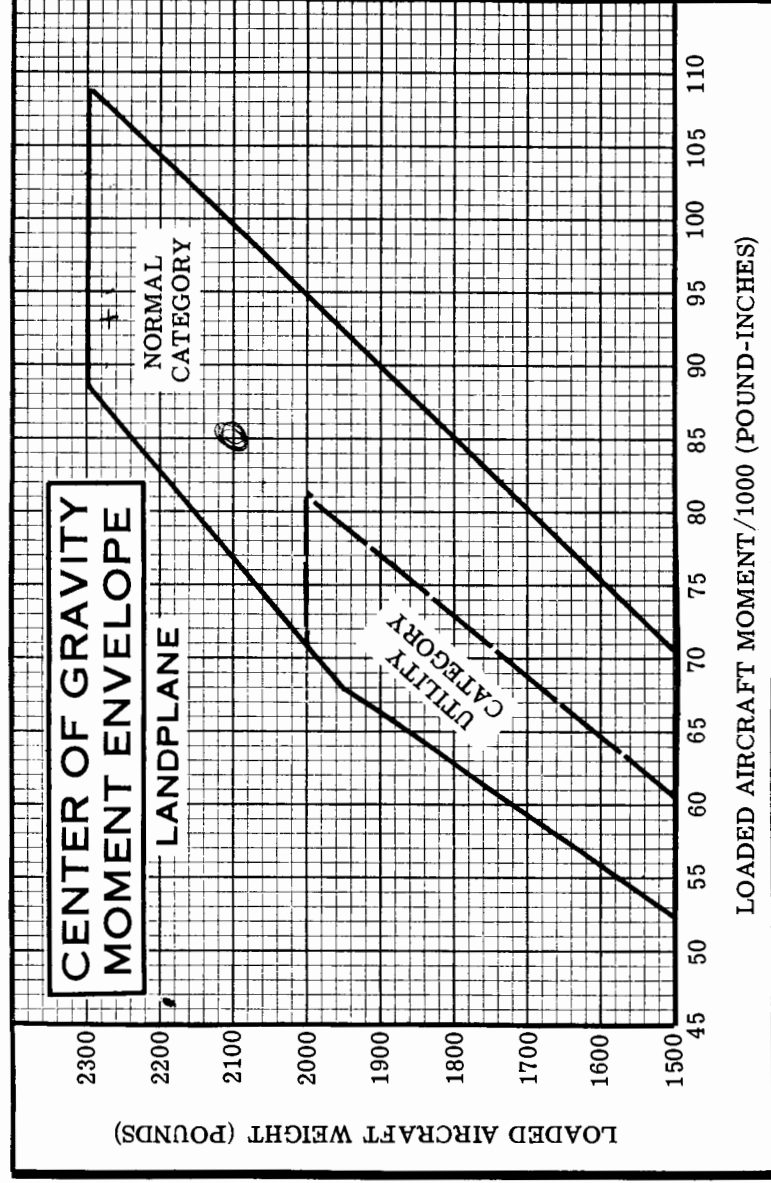

Figure 6-7. Center of Gravity Moment Envelope

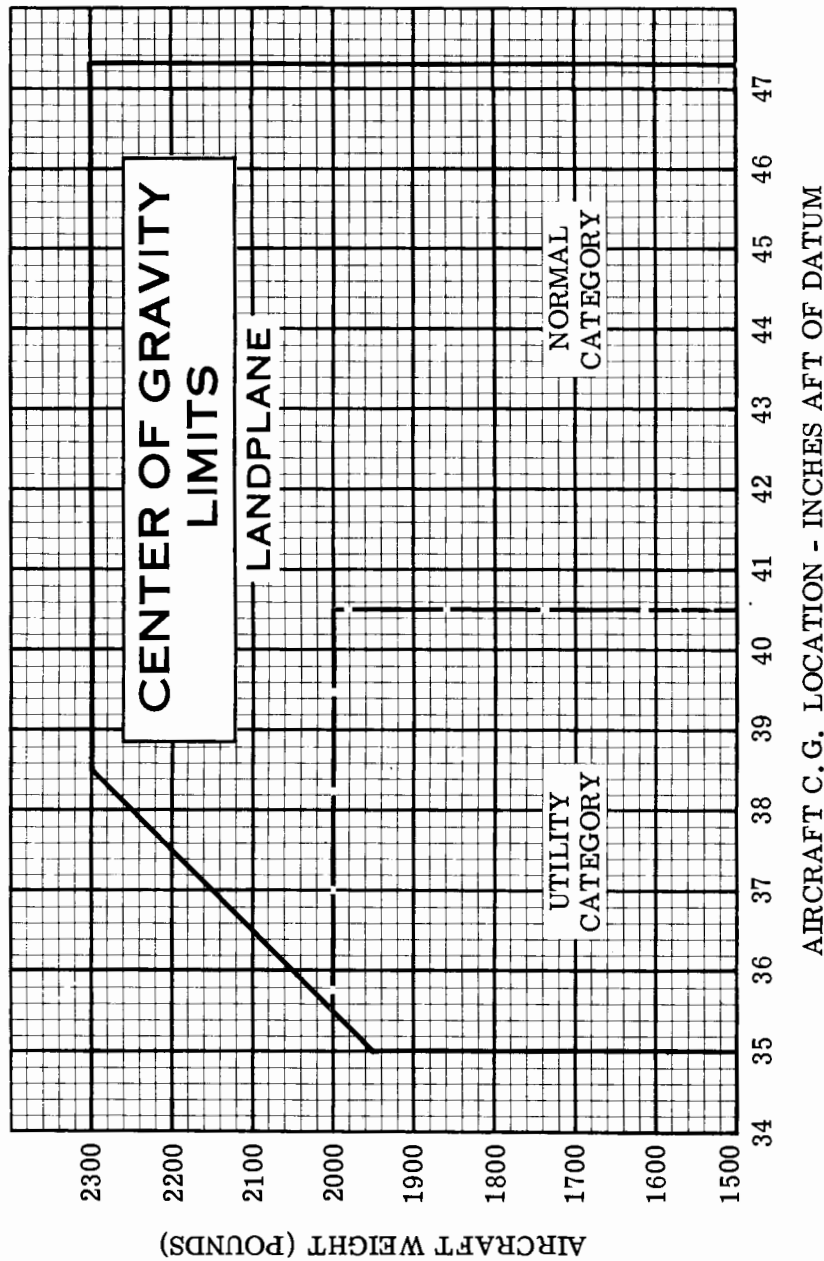

Figure 6-8. Center of Gravity Limits

## EQUIPMENT LIST

The following equipment list is a comprehensive list of all Cessna equipment available for this airplane. A separate equipment list of items installed in your specific airplane is provided in your aircraft file. The following list and the specific list for your airplane have a similar order of listing.

This equipment list provides the following information:

An item number gives the identification number for the item. Each number is prefixed with a letter which identifies the descriptive grouping (example: A. Powerplant & Accessories) under which it is listed. Suffix letters identify the equipment as a required item, a standard item or an optional item. Suffix letters are as follows:

- R = required items of equipment for FAA certification
- S = standard equipment items
- O = optional equipment items replacing required or standard items
- A = optional equipment items which are in addition to required or standard items

A reference drawing column provides the drawing number for the item.

### NOTE

If additional equipment is to be installed, it must be done in accordance with the reference drawing, accessory kit instructions, or a separate FAA approval.

Columns showing weight (in pounds) and arm (in inches) provide the weight and center of gravity location for the equipment.

### NOTE

Unless otherwise indicated, true values (not net change values) for the weight and arm are shown. Positive arms are distances aft of the airplane datum; negative arms are distances forward of the datum.

### NOTE

Asterisks (\*) after the item weight and arm indicate complete assembly installations. Some major components of the assembly are listed on the lines immediately following. The summation of these major components does not necessarily equal the complete assembly installation.

SECTION 6  
WEIGHT & BALANCE/  
EQUIPMENT LIST

CESSNA  
MODEL 172M

ITEM NO	EQUIPMENT LIST DESCRIPTION	REF DRAWING	WT LBS	ARM INS
	A. POWERPLANT & ACCESSORIES		266.0*	-20.0*
A01-R	ENGINE, LYCOMING O-320-E2D (INCLUDES ALL ELECTRICAL STARTER AND VACUUM PAD)	0550319		
A05-R	FILTER, CARBURETOR AIR	C294510-0301	0.5	-29.0
A09-R	ALTERNATOR 14 VOLT, 60 AMP (BELT DRIVE)	C911501-0102	10.8*	-22.5*
A17-R	OIL COOLER INSTALLATION OR OIL COOLER (HARRISON OR STEWART WARNER)	0550319	2.1	-2.5*
A21-A	FILTER INSTALLATION, FULL FLOW ENGINE OIL ADAPTOR ASSY (LYCOMING)	1756004-1	0.8*	-5.0*
	FILTER CAN ASSY (AC)	755288	1.8	-3.3
	FILTER ELEMENT (AC)	6436992	0.3	-3.3
A33-R	PROPELLER ASST. (FIXED PITCH-LANDPLANE)	C111001-0306	35.9*	-39.1
	PROPELLER (MCCAULEY)	C111001/DTM7553	30.1	-35.4*
A33-O	3.5 INCH PROP SPACER ADAPTOR (MCCAULEY)	C4516	37.5*	-39.1
	PROPELLER ASSY. (FIXED PITCH-FLOATPLANE)	C161001-0307	31.5	-39.1
A41-R	3.5 INCH PROP SPACER ADAPTOR (MCCAULEY)	1A175/ETM8042	3.6	-35.4*
	SPINNER DOME	0550320	2.0*	-41.4*
	SPINNER BULKHEAD	0550321-8	1.2	-43.1
	AFT SPINNER BULKHEAD	0550321-4	1.0	-40.8
A61-S	VACUUM SYSTEM INSTALLATION DRY VACUUM PUMP (AV WT OF 4 TYPES)	0550325-2	0.4*	-37.0*
	FILTER	0550325-1	0.3*	-37.0*
	VACUUM GAUGE	C294502-0101	2.0	-6.3
A70-A	RELIEF VALVE-REGULATOR	C668509-0101	0.2	-4.7
A73-A	PRIMER SYSTEM ENGINE THREE CYLINDER OIL QUICK DRAIN VALVE (NET CHANGE)	C482001-0401	0.1	16.2
		1701015	0.5	-12.0
		1701015	0.0	-

CESSNA  
MODEL 172M

SECTION 6  
WEIGHT & BALANCE/  
EQUIPMENT LIST

ITEM NO	EQUIPMENT LIST DESCRIPTION	REF DRAWING	WT LBS	ARM INS
	B. LANDING GEAR & ACCESSORIES			
B01-R	WHEEL, BRAKE & TIRE ASSY, 6.00X6 MAIN (2)	C163015-0201 OR	41.7*	57.8*
	WHEEL ASSY., MCCAULEY D30260 (EACH)	C163003-0101 OR	6.4	58.2
	BRAKE ASSY., MCCAULEY (LEFT)	C163015-0102	1.9	54.5
	BRAKE ASSY., MCCAULEY (RIGHT)	C163032-0111	8.5	54.5
	TIRE, 4-PLY BLACKWALL (EACH)	C262003-0101	1.8	58.2
	TUBE (EACH)	C262003-0102	1.8*	58.2
B04-R	WHEEL, TIRE ASS. 5.00X5 NOSE	C163015-0109	3.0	-6.8*
	WHEEL ASSY., MCCAULEY	C163003-0401	3.0	-6.8
	TIRE, 4-PLY, BLACKWALL	C262003-0102	4.7	-6.8
B10-S	FAIRING INSTALLATION, WHEEL (SET OF 3)	C262023-0101	17.8*	47.1*
	NOSE WHEEL FAIRING (EACH)	0541225-1	4.0	-4.9
	MAIN WHEEL FAIRING		5.7	60.3
	C. ELECTRICAL SYSTEM			
C01-R	BATTERY, 12 VOLT, 25 AMP HOUR	0511319	23.0	0.0
C04-R	REGULATOR, 14 VOLT, 60 AMP ALTERNATOR	C611001-0201	0.5	3.5
C07-A	GROUND SERVICE PLUG RECEPTACLE	0501053	2.7*	-24.4
C16-O	HEATING SYSTEM, PITOT (NET CHANGE)	0422355	0.6	16.5
C25-A	LIGHTS, INSTRUMENT POST	0513094	0.5	16.5
C25-A	LIGHT, MAP & INSTRUMENT WHEEL MOUNTED)	0470087	0.2	32.0
C28-S	LIGHT, MAP & INSTRUMENT PANEL FLOOD (DOOR POST MOUNTED)	0700149	0.3	32.0
C31-A	LIGHTS, COURTESY ENTRANCE (SET OF 2)	0521101	0.5	61.0
C40-A	DETECTORS, NAVIGATION LIGHT (SET OF 2)	0701013-1, -2	NEGL	-
C43-A	LIGHT INSTALLATION, OMNIFLASH BEACON	0506003	2.1*	184.0*
	BEACON LIGHT ON FIN TIP	C621001-0103	0.8	243.0
	FLASHER (POWER SUPPLY)	C594502-0101	0.3	208.1
C46-A	RESISTOR (MEMCOR)	0R95-1.5	3.4*	43.3*
	LIGHT INSTALLATION, WING TIP STROBE	0501027	2.3	47.0
	FLASHER POWER SUPPLY (SET OF 2 IN WING)	C622007-0101	0.3	47.0

SECTION 6  
WEIGHT & BALANCE/  
EQUIPMENT LIST

CESSNA  
MODEL 172M

ITEM NO	EQUIPMENT LIST DESCRIPTION	REF DRAWING	WT LBS	ARM INS
C49-S	STROBE LIGHT, WING TIP (SET OF 2) LIGHT INSTALLATION, COWL MOUNTED LANDING LAMP, 250 WATT (G.E.)	C622006 0501016 4522	0.2* 1.9* 0.8	43.5* -29.1* -27.0
C49-O	LIGHTS, DUAL COWL MOUNTED LANDING LAMP, 250 WATT (G.E.) (EACH)	0552141 4509	3.2* 0.5	-23.0* -29.0
D. INSTRUMENTS				
D01-R	INDICATOR, AIRSPEED	C661064-0102	0.9	16.2
D01-O	INDICATOR, TRUE AIRSPEED	0513279	0.9	16.3
D04-A	STATIC AIR ALTERNATE SOURCE	0501017	0.2	16.5
D07-R	ALTIMETER (SENSITIVE)	C661071-0101	1.0	14.0
D07-O-1	ALTIMETER (SENSITIVE) FEET & MILLIBARS	C661071-0102	1.0	14.0
D07-O-2	ALTIMETER (SENSITIVE) 20FT. MARKINGS	C661071-0102	1.0	14.0
D10-A	ALTIMETER, 2ND UNIT INSTALLATION (DUAL)	C661025-0102	1.0	14.5
D16-A-1	ENCODING ALTIMETER (REQUIRES RELOCATION OF REGULAR ALTIMETER)	Z001015 0501049	3.0	14.0
D16-A-2	ENCODING ALTIMETER, FEET & MILLIBARS (RE- QUIRES RELOCATION OF REGULAR ALTIMETER)	0501049	3.0	14.0
D19-R	AMMETER	0501049	3.0	14.0
D22-A	GAGE, CARBURETOR AIR TEMPERATURE	S-1320-5	0.3	16.5
D25-S	CLOCKS, ELECTRICALLY-INSTALLATION	0513239	1.0	14.0
D28-R	COMPASS, MAGNETIC-INSTALLATION	C664508-0101	0.4	16.5
D38-R	INSTRUMENT CLUSTER, LH & RH FUEL QUANTITY	0513262-1	0.5	14.0
D41-R	INSTRUMENT CLUSTER, OIL PRESS, OIL TEMP.	C669511-0102	0.5	16.5
D64-S	GYROS, ATTITUDE & DIRECTIONAL INDICATORS (NON-NAV-O-MATIC)	C669512-0102	0.5	16.5
D64-S	GYROS, ATTITUDE & DIRECTIONAL INDICATORS (AV. OF 4)	0501054-1	5.8*	14.0*
D64-O-1	ALTIMETER INDICATOR (AV. OF 3) INSTALLATION (SIMILAR TO D64-S EXCEPT DIRECTIONAL INDICATOR HAS A MOVEABLE HEADING POINTER) (INDICATOR NET CHANGE)	C661075 C661076 1201126-1	2.7 2.2 6.3*	13.2 13.4 13.9*
D64-O-2	GYRO INSTALLATION FOR 300A NAV-O-MATIC	0501054-2	6.9*	13.4*
D67-A	DIRECTIONAL INDICATOR (ARC)	40760	3.3	13.3
D82-S	RECORDING INSTALLATION, FLIGHT HOUR GAGE, OUTSIDE AIR TEMPERATURE	0501052	0.8	12.3
D85-R	TACHOMETER INSTALLATION, ENGINE RECORDING TACH INDICATOR (SW 551-RB)	C668507-0101 0508004 C668020-0102	0.1 1.0* 0.7	28.6 12.1* 16.0

CESSNA  
MODEL 172M

SECTION 6  
WEIGHT & BALANCE/  
EQUIPMENT LIST

ITEM NO	EQUIPMENT LIST DESCRIPTION	REF DRAWING	WT LBS	ARM INS
D88-S	FLEXIBLE TACH SHAFT (ASES 1605-31)	S-1605-8	0.3	3.0
D88-O-1	INDICATOR, TURN COORDINATOR (FOR USE WITH NAV-O-MATIC 200A AND 300A)	C661003-0504 42320-0014	1.9	14.6
D88-C-2	INDICATOR, TURN & BANK (NOT COMPATIBLE WITH NAV-O-MATIC)	S-1413N2	2.0	14.5
D91-S	INDICATOR, RATE OF CLIMB	C661080-0101	1.0	14.9
E. CABIN ACCOMMODATIONS				
E02-S	ARM RESTS - 2ND ROW (SET OF 2)	0715039	1.5	72.5
E03-R	SEAT, ADJUSTABLE FORE & AFT PILOT	S-1746-5	12.6	44.0
E03-O	SEAT, INFINITE ADJUSTABLE - PILOT	0714005-1	23.0	41.5
E07-S	SEAT, ADJUSTABLE FORE & AFT - CO-PILOT	S2240-103	12.6	44.0
E07-O	SEAT, INFINITE ADJUSTABLE - CO-PILOT	S2240-201	23.0	41.5
E09-S	SEAT, REAR (ONE PIECE BACK CUSHION)	S2240-3VH	23.0	79.5
E09-O	SEAT, REAR (TWO PIECE BACK CUSHION)	0501009	23.0	79.5
E11-A	SEAT, INSTALLATION, CHILDS FOLD AWAY LAP BELT ASSY	S-1746-5	8.4*	101.1*
E15-R	PILOT LAP BELT ASSY	S-1746-5	0.8	100.8
E15-S	SHOULDER HARNESS ASSY, PILOT	S2240-103	6.7	100.8
E15-O	BELT & SHOULDER HARNESS, PILOT (FOR AUSTRALIA, NET CHANGE)	S2240-201	1.0	37.0
E19-O	SHOULDER HARNESS INERTIA REEL INSTALLATION PILOT & CO-PILOT - REPLACES STD BELTS AND HARNESS (NET CHANGE)	0501046-1	0.0	-
E23-S	BELT & SHOULDER ASSY - CO-PILOT	S2240-3	2.0	82.0
E23-O	BELT & SHOULDER HARNESS ASSY, CO-PILOT (FOR AUSTRALIA, NET CHANGE)	S2240-3VH	1.6	37.0
E27-S	BELT ASSY, 2ND ROW (SET OF 2)	S1746-13	3.2	70.0
E27-O-1	BELT & SHOULDER HARNESS ASSY, 2ND ROW, SET OF 2	S2240-8	3.2	70.0
E27-O-2	BELT & SHOULDER HARNESS ASSY, 2ND ROW (FOR AUSTRALIA)	S2240-8VH	3.2	70.0
E35-A	LEATHER SEAT COVERING (NET CHANGE)	CES-1151	2.0	62.0
E37-A	WINDOW, HINGED, RH DOOR (NET CHANGE)	0511803	2.3	47.0
E39-A	WINDOWS, OVERHEAD CABIN TOP (NET CHANGE)	0511800	0.9	47.9
E43-A	VENTILATION SYSTEM, REAR SEAT	0501026	1.5	60.0

SECTION 6  
WEIGHT & BALANCE/  
EQUIPMENT LIST

CESSNA  
MODEL 172M

ITEM NO	EQUIPMENT LIST DESCRIPTION	REF DRAWING	WT LBS	ARM INS
E49-A	BEVERAGE CUP HOLDER	0501023	0.1	15.0
E50-A	HEADREST, 1ST ROW (WT EACH)	1215073-11	0.7	47.0
E51-A	HEADREST, 2ND ROW (WT EACH)	1215073-11	0.7	86.0
E53-A	MIRROR, REAR VIEW	0500312	0.3	15.9
E55-S	SUN VISORS (SET OF 2)	0500040	0.0	32.8
E57-A	WINDOWS, TINTED FRONT, SIDE & REAR (NET CHANGE)	0500267	0.0	-
E65-S	BAGGAGE NET	2015009	0.5	95.0
E71-A	RINGS, CARGO TIE-DOWN (STOWED)(USE ARM AS INSTALLED WITH CARGO)	0500042	1.0	-
E75-A	STRETCHER INSTALLATION - BOXED (USE ACTUAL WEIGHT AND ARM CHANGE)	0700164-4	-	-
E85-A	CONTROLS INSTALLATION, DUAL HEATING SYSTEM, CABIN & CARGO (INCLUDES EXHAUST SYSTEM)	0513335 0550319 0506004	4.9 17.5	12.4 -21.0
F01-R	F. PLACARDS & WARNING			
F01-0-1	PLACARD, OPERATIONAL LIMITATIONS-DAY VFR	0505053-1	NEGL	-
F01-0-2	PLACARD, OPERATIONAL LIMITATIONS-DAY NIGHT VFR	0505053-2	NEGL	-
F01-0-3	PLACARD, OPERATIONAL LIMITATIONS-DAY NIGHT VFR	0505053-3	NEGL	-
F01-0-4	PLACARD, OPERATIONAL LIMITATIONS-DAY NIGHT VFR	0505053-16	NEGL	-
F01-0-5	PLACARD, OPERATIONAL LIMITATIONS-DAY NIGHT VFR	0505053-17	NEGL	-
F04-R	NOTE THE ABOVE PLACARDS ARE INSTALLED ACCORDING TO AIRCRAFT EQUIPMENT	0505053-18	NEGL	-
F13-S	INDICATOR, AUDIBLE PNEUMATIC STALL WARNING OVERVOLT WARNING LIGHT, ALTERNATOR	0523112	0.2 NEGL	28.5 -

CESSNA  
MODEL 172M

SECTION 6  
WEIGHT & BALANCE/  
EQUIPMENT LIST

ITEM NO	EQUIPMENT LIST DESCRIPTION	REF DRAWING	WT LBS	ARM INS
G04-A	G. AUXILIARY EQUIPMENT			
G07-A	TOW HOOK (INSTALLED) (STOWED)	0500228	0.5	229.0
G13-A	RINGS, AIRPLANE HOISTING (CABIN TOP)	0541115	0.1	49.1
G16-A	CORROSION PROOFING, INTERNAL	0500036	10.0	77.0
G19-A	STATIC DISCHARGERS	0501048	0.4	143.2
G22-S	STABILIZER ABRASION BOOTS	0500041	2.7	206.0
G25-S	TOW BAR (STOWED)	2001014	1.6	95.0
G25-S	PAINT OVERALL EXTERIOR COVER	0504030	11.4*	91.5*
G25-S	OVERALL WHITE BASE		10.8	90.5
G25-O	COLOR STRIPE - SKYHAWK II		10.9	109.3
G31-A	PAINT SCHEME - SKYHAWK II	0504030	11.4	109.3
G31-A	CABLES, CORROSION RESISTANT CONTROL (NET CHANGE)	0500036	0.0	-
G55-A	FIRE EXTINGUISHER INSTALLATION	0501011	3.0*	43.8*
G58-A	FIRE EXTINGUISHER MOUNTING BRACKET	C421001-0101	2.6	44.0
G88-A-1	STEPS, HANDLES, REFUELING ASSISTING WINTERIZATION KIT INSTALLATION, ENGINE TUBERIZATION TUBE INSULATION	C421001-0102	0.3	42.2
G88-A-1	TWO COWL INLET AIR COVERS (INSTALLED) (STOWED)	0513415	1.7	17.8
G88-A-2	WINTERIZATION KIT INSTL.; FLOATPLANE ONLY	051008-1	0.8*	-22.7*
G92-O	BREATHER TUBE INSULATION (INSTALLED) (STOWED)	0522011	0.4	-13.8
	COWL OUTLET COVER (1) (INSTALLED) (STOWED)	0522132-1; -2	0.3	-32.0
	FUEL SYSTEM, LONG RANGE WING TANKS (NET CHANGE)	0552011	1.0*	-95.0*
			0.6	-12.0
			0.6	95.0
			9.5	48.0
H01-A	H. AVIONICS & AUTOPILOTS			
H01-A	CESSNA 300 ADF INSTALLATION 2ND UNIT	3410137-18	7.4*	20.6*
	CONSISTS OF			
	RECEIVER WITH BFO (R-546E)	41240-0101	2.3	12.1
	INDICATOR (IN-346A)	40980-1001	0.9	14.0

SECTION 6  
WEIGHT & BALANCE/  
EQUIPMENT LIST

CESSNA  
MODEL 172M

ITEM NO	EQUIPMENT LIST DESCRIPTION	REF DRAWING	WT LBS	ARM INS
H04-A	AVIONICS OPTION C1 (ITEM H40-A) DME INSTALLATION, NARCO RECEIVER (OME-190) MOUNTING BOX	3910154-18 3910166-1	4.2 7.5* 4.9 11.3 0.6 0.2	26.6 18.5* 11.3 11.3 86.1* 117.3 73.6*
H07-A	CESSNA 400, GLIDESLOPE RECEIVER (K-443B)	UDA-3 3910119-2	0.3* 4.3*	82.6*
H10-A-1	ANTENNA (LOCATED-UPPER WINDSHIELD) PANTRONICS PT-10A HF TRANSCEIVER 1ST UNIT CONSISTS OF RADIO COOLING HF POWER SUPPLY (REMOTE) ANTENNA LOAD BOX (PANEL MOUNTED) TRANSCEIVER (PANEL MOUNTED) ANTENNA INSTALLATION, 351 IN. LONG CABLE ASSEMBLIES HEADSET INSTALLATION MICROPHONE INSTALLATION AUDIO SWITCHING CONTROL NOISE FILTER (ALTERNATOR) SPEAKER ASSY SPLIT BUS BAR, INCLUDES RELAY PANTRONICS PT-10A HF TRANSCEIVER 2ND UNIT TRANSCEIVER (PANEL MOUNTED) ANTENNA LOAD BOX HF POWER SUPPLY (REMOTE) NOISE FILTER, HIGH FREQ. SWITCHES & RELAY WIRES POWER & SIGNAL CABLES SUNAIR ASB-125 HF TRANSCEIVER, 2ND UNIT ANTENNA LOAD BOX POWER SUPPLY (REMOTE) TRANSCEIVER (PANEL MOUNTED) CESSNA 400 MARKER BEACON RECEIVER (R-402A) ANTENNA, L SHAPED ROD CESSNA 300 TRANSPONDER TRANSCEIVER (RT-359A) ANTENNA (A-109A) CESSNA 300 VHF TRANSCEIVER, 1ST UNIT TRANSCEIVER (RT-524A)	3910122-1 C582103-0201 C582103-0101 C582103-0102 0570400-616 3950122-15 3970125-4 3970124-1 3970124-1 0570400-737 C596504-0201 0570400-744 0570400-9 3910156-9 C582103-0102 C589502-0101 C582103-0201 0570400-715 3970122-4 0570400-126 98516 99680 99680 3910142-2 42410-5114 0770681-1 3910127-17 41420-1114 41550-0001 3910133-1 31390-1114	1.1 10.2 11.4 112.5 112.5 10.4 144.0 14.0 11.2 11.2 -26.1 37.9 5.4 87.3* 10.4 112.5 114.4 12.0 0.4 2.5 22.4* 4.9 112.0 9.5 4.6 2.3* 0.7 0.8 4.8* 2.7 0.3 10.6* 15.7	
H10-A-2				
H10-A-3				
H13-A				
H16-A				
H19-A				

CESSNA  
MODEL 172M

SECTION 6  
WEIGHT & BALANCE/  
EQUIPMENT LIST

ITEM NO	EQUIPMENT LIST DESCRIPTION	REF DRAWING	WT LBS	ARM INS
H22-A-1	PARTIAL OPTION A-1 (MODIFIED) NOTE THIS UNIT USES OPTION A1 MODIFIED DELETE OMNI ANTENNA, OMNI CABLE & WIRING CHANGES AS NEEDED CESSNA 300 NAV/COM, 160 CH, FIRST UNIT WITH VOR/LOC RECEIVER-TRANSMITTER (RT-308C) VOR/LOC INDICATOR (IN-5148)	3910151-7 42450-1114 45010-1000 3910154-16 3910150-20	4.9 14.3* 6.4 0.6 7.3 14.8*	22.4 31.5* 11.5 16.3 50.3 30.8*
H22-A-2	AVIONICS OPTION A1 (ITEM H34-A) WITH VOR/LOC RECEIVER-TRANSMITTER (RT-328T) VOR/LOC INDICATOR (IN-5148)	43340-1124 45010-1000 3910154-16 3910152-20	6.9 0.6 7.3 14.9*	11.5 16.3 50.3 30.7*
H22-A-3	AVIONICS OPTION A1 (ITEM H34-A) WITH VOR/LOC RECEIVER-TRANSMITTER (RT-328T) VOR/LOC INDICATOR (IN-5148)	43340-1124 45010-1000 3910154-16 3910150-13	6.9 0.7 7.3 14.9*	11.5 16.3 50.3 30.7*
H22-A-4	AVIONICS OPTION A1 (ITEM H34-A) WITH VOR/LOC RECEIVER-TRANSMITTER (RT-328T) VOR/LOC INDICATOR (IN-5148)	43340-1124 45010-1000 3910154-16 3910150-13	6.9 0.6 7.3 14.9*	11.5 16.3 50.3 30.7*
H22-A-5	AVIONICS OPTION A1 (ITEM H34-A) WITH VOR/LOC RECEIVER-TRANSMITTER (RT-328T) VOR/LOC INDICATOR (IN-5148)	43340-1124 45010-1000 3910154-16 3910152-13	7.0 0.6 7.3 15.0*	11.5 16.3 50.3 30.6*
H25-A-1	AVIONICS OPTION A1 (ITEM H34-A) WITH VOR/LOC RECEIVER-TRANSMITTER (RT-328T) VOR/LOC INDICATOR (IN-5148)	42430-1124 45010-1000 3910154-16 3910151-8	7.0 0.7 7.3 9.9*	11.5 16.3 50.3 14.3*
H25-A-2	AVIONICS OPTION B1 (ITEM H37-A) WITH VOR/LOC RECEIVER-TRANSMITTER (RT-308C) VOR/LOC INDICATOR (IN-5148)	42450-1114 45010-1000 3910154-17 3910150-21	6.4 0.6 2.9 10.4*	11.5 16.3 20.1 14.2*
H25-A-3	AVIONICS OPTION B1 (ITEM H37-A) WITH VOR/LOC RECEIVER-TRANSMITTER (RT-328T) VOR/LOC INDICATOR (IN-5148)	43340-1124 45010-1000 3910154-17 3910150-14	6.9 0.6 2.9 10.5*	11.5 16.3 20.1 14.2*





# SECTION 7 AIRPLANE & SYSTEMS DESCRIPTIONS

ITEM NO	EQUIPMENT LIST DESCRIPTION	REF DRAWING	WT LBS	ARM INS
J30-A-1	INCLUDES J30-A-1 AND REPLACES ITEMS 804-R, BRAKE & NOSE WHEEL STEERING SYSTEMS, AND THE WT & ARM SHOWN ARE APPROXIMATE, AND FOR REFERENCE ONLY. USE ACTUAL INSTALLED WT & ARM CHANGE. FLOATPLANE EQUIPMENT KIT, COMPLETE, OPTION A CONSISTS OF ITEMS A33-0- PROPELLER, FLOATPLANE, EXCHANGE F01-0- PLACARD, FLOATPLANE OPERATION G31-A- CABLES, CORROSION RESIST, EXCH. G32-A- CORROSION PROOFING INTERNAL G37-A- RINGS, AIRPLANE HOISTING G58-A- STEP & HANDLE, REFUELING J10-A- FUSELAGE MODIFICATION (OPT C) J13-A- COWL DECK V-BRACE (INSTALLED) J15-A- INTERCONNECT SYSTEM, INSTALLED COWL ASSY, FLOATPLANE (NET CHANGE) FLOATPLANE EQUIPMENT KIT, PARTIAL OPTION B CONSISTS OF ITEMS F01-0- PLACARD, FLOATPLANE OPERATION G31-A- CABLES, CORROSION RESIST, EXCH G32-A- CORROSION PROOFING INTERNAL G07-A- RINGS, AIRPLANE HOISTING G58-A- STEP & HANDLE, REFUELING J10-A- FUSELAGE MODIFICATION J11-A- COWL DECK V-BRACE (STOWED) J15-A- INTERCONNECT SYSTEM (STOWED) COWL ASSY, FLOATPLANE (NET CHANGE) FLOATPLANE KIT B WITH NO INTERNAL CORROSION PROOFING G58-A- STEP & HANDLE, REFUELING J10-A- FUSELAGE MODIFICATIONS J13-A- COWL DECK V-BRACE (INSTALLED) J15-A- INTERCONNECT SYSTEM (STOWED) COWL ASSY, FLOATPLANE	0500083 0550320 0505053 0500036 0500036 0541115 0513415 0500083 0513003 0560012 0552112-32 0500083 0505053 0500036 0500036 0541115 0513415 0500083 0513003 0560012 0552112-32 0500083-17 0541115 0513415 0500083 0513003 0560012 0552112-32	21.7* 1.3 0.0 0.0 10.0 1.7 1.7 6.1 1.1 0.4 NEGL 20.4*	52.3* -41.4 - 77.0 49.1 17.8 45.5 26.2 69.6 - 62.5* - - 77.0 49.1 17.8 45.5 95.0 - 41.2* 49.1* - - 17.8 45.5 26.2 95.0 -
J30-A-2				
J30-A-3				

## TABLE OF CONTENTS

	Page
Introduction . . . . .	7-3
Airframe . . . . .	7-3
Flight Controls . . . . .	7-8
Trim System . . . . .	7-8
Instrument Panel . . . . .	7-8
Ground Control . . . . .	7-9
Wing Flap System . . . . .	7-9
Landing Gear System . . . . .	7-10
Baggage Compartment . . . . .	7-10
Seats . . . . .	7-11
Seat Belts and Shoulder Harnesses . . . . .	7-12
Seat Belts . . . . .	7-12
Shoulder Harnesses . . . . .	7-12
Integrated Seat Belt/Shoulder Harnesses With Inertia Reels . . . . .	7-15
Entrance Doors and Cabin Windows . . . . .	7-15
Control Locks . . . . .	7-16
Engine . . . . .	7-17
Engine Controls . . . . .	7-17
Engine Instruments . . . . .	7-17
New Engine Break-in and Operation . . . . .	7-18
Engine Oil System . . . . .	7-18
Ignition-Starter System . . . . .	7-19
Air Induction System . . . . .	7-20
Exhaust System . . . . .	7-20
Carburetor and Priming System . . . . .	7-20
Cooling System . . . . .	7-21
Propeller . . . . .	7-21
Fuel System . . . . .	7-21
Brake System . . . . .	7-24
Electrical System . . . . .	7-24
Master Switch . . . . .	7-26
Ammeter . . . . .	7-26

## TABLE OF CONTENTS (Continued)

	Page
Over-Voltage Sensor and Warning Light . . . . .	7-26
Circuit Breakers and Fuses . . . . .	7-27
Ground Service Plug Receptacle . . . . .	7-27
Lighting Systems . . . . .	7-28
Exterior Lighting . . . . .	7-28
Interior Lighting . . . . .	7-28
Cabin Heating, Ventilating and Defrosting System . . . . .	7-29
Pitot-Static System and Instruments . . . . .	7-31
Airspeed Indicator . . . . .	7-32
Rate-of-Climb Indicator . . . . .	7-32
Altimeter . . . . .	7-32
Vacuum System and Instruments . . . . .	7-32
Attitude Indicator . . . . .	7-34
Directional Indicator . . . . .	7-34
Suction Gage . . . . .	7-34
Stall Warning System . . . . .	7-34
Avionics Support Equipment . . . . .	7-35
Audio Control Panel . . . . .	7-35
Transmitter Selector Switch . . . . .	7-35
Automatic Audio Selector Switch . . . . .	7-35
Audio Selector Switches . . . . .	7-37
Microphone - Headset . . . . .	7-37
Static Dischargers . . . . .	7-37

## INTRODUCTION

This section provides description and operation of the airplane and its systems. Some equipment described herein is optional and may not be installed in the airplane. Refer to Section 9, Supplements, for details of other optional systems and equipment.

## AIRFRAME

The construction of the fuselage is a conventional formed sheet metal bulkhead, stringer, and skin design referred to as semi-monocoque. Major items of structure are the front and rear carry-through spars to which the wings are attached, a bulkhead and forgings for main landing gear attachment at the base of the rear doorposts, and a bulkhead with attaching plates at the base of the forward doorposts for the lower attachment of the wing struts. Four engine mount stringers are also attached to the forward doorposts and extend forward to the firewall.

The externally braced wings, containing the fuel tanks, are constructed of a front and rear spar with formed sheet metal ribs, doublers, and stringers. The entire structure is covered with aluminum skin. The front spars are equipped with wing-to-fuselage and wing-to-strut attach fittings. The aft spars are equipped with wing-to-fuselage attach fittings, and are partial-span spars. Conventional hinged ailerons and single-slotted flaps are attached to the trailing edge of the wings. The ailerons are constructed of a forward spar containing a balance weight, formed sheet metal ribs and "V" type corrugated aluminum skin joined together at the trailing edge. The flaps are constructed basically the same as the ailerons, with the exception of the balance weight and the addition of a formed sheet metal leading edge section.

The empennage (tail assembly) consists of a conventional vertical stabilizer, rudder, horizontal stabilizer, and elevator. The vertical stabilizer consists of a spar, formed sheet metal ribs and reinforcements, a wrap-around skin panel, formed leading edge skin, and a dorsal. The rudder is constructed of a formed leading edge skin containing hinge halves, a center wrap-around skin panel, ribs, an aft wrap-around skin panel which is joined at the trailing edge of the rudder by a filler strip, and a ground adjustable trim tab at the base of the trailing edge. The top of the rudder incorporates a leading edge extension which contains a balance weight. The horizontal stabilizer is constructed of a forward and aft spar, ribs and stiffeners, center, left, and right wrap-around skin panels, and formed leading edge skins. The horizontal stabilizer also contains the elevator trim tab actuator. Construction of the elevator consists of formed leading edge skins, a forward spar, aft channel, ribs, torque tube and

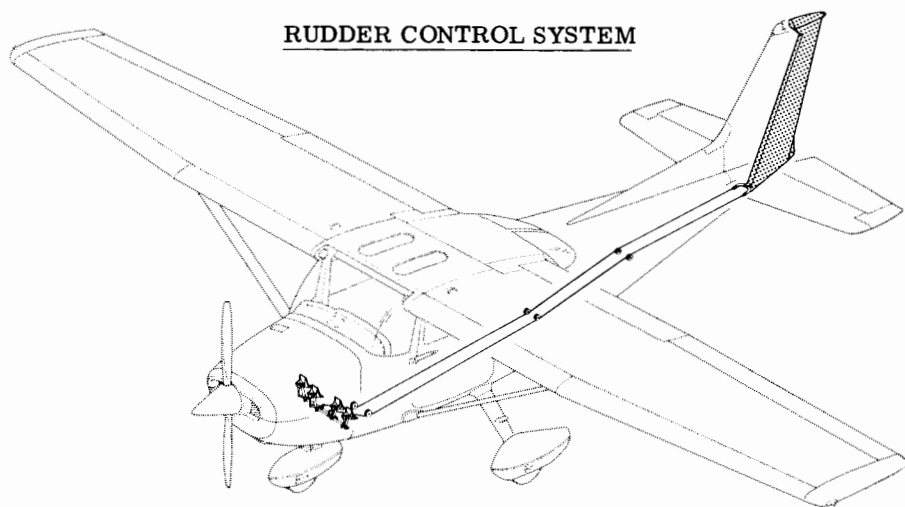
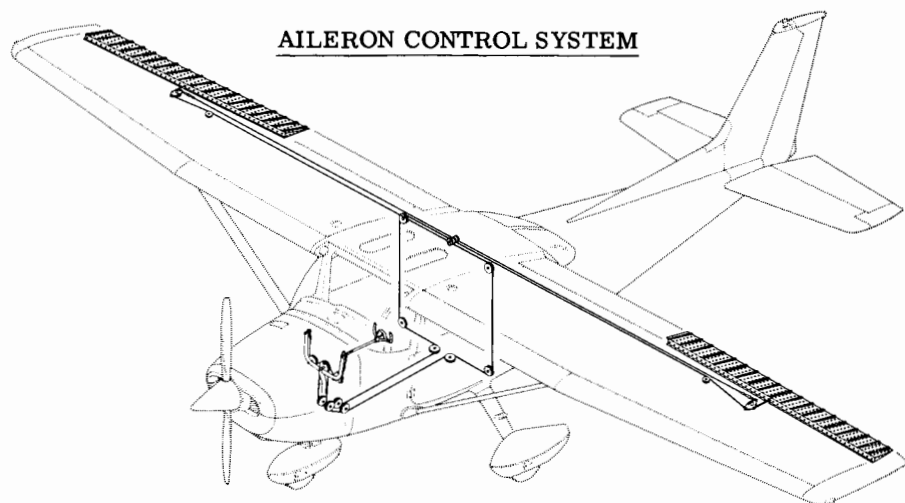

Figure 7-1. Flight Control and Trim Systems (Sheet 1 of 2)

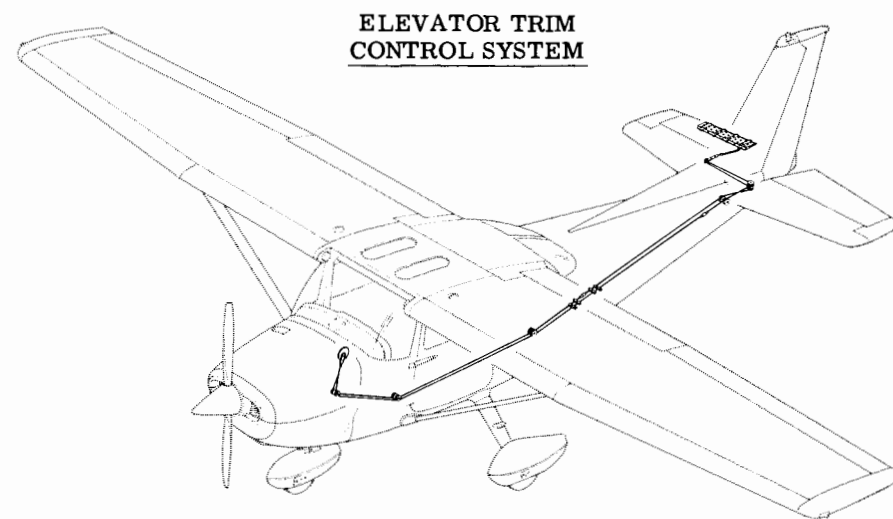
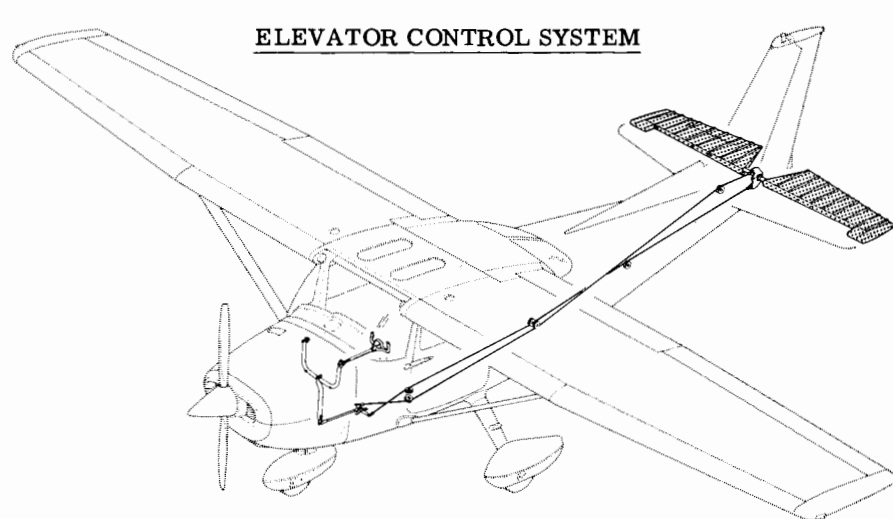

Figure 7-1. Flight Control and Trim Systems (Sheet 2 of 2)

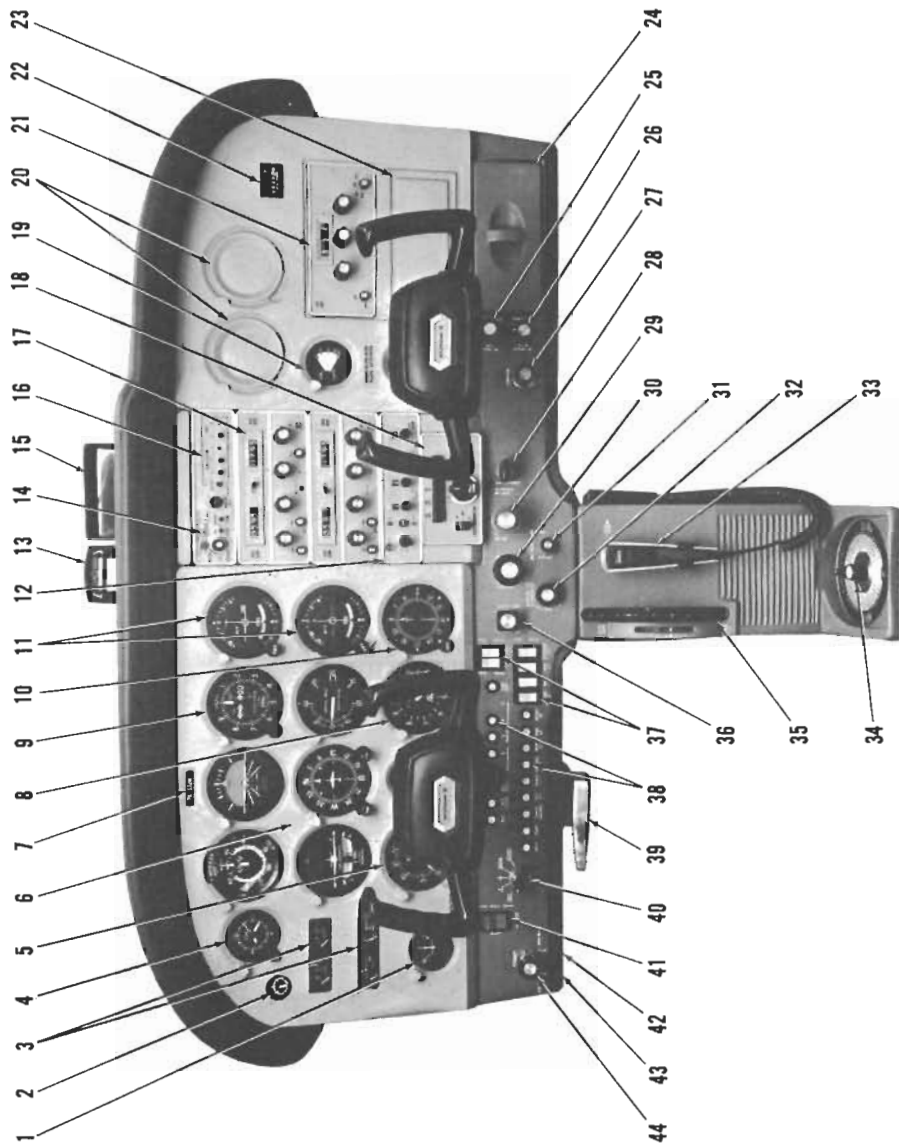

Figure 7-2. Instrument Panel (Sheet 1 of 2)

- |   |   |
|---|---|
| <ol style="list-style-type: none"> <li>1. Ammeter</li> <li>2. Suction Gage</li> <li>3. Oil Temperature, Oil Pressure, and Left and Right Fuel Gages</li> <li>4. Clock</li> <li>5. Tachometer</li> <li>6. Flight Instrument Group</li> <li>7. Airplane Registration Number</li> <li>8. Secondary Altimeter</li> <li>9. Encoding Altimeter</li> <li>10. ADF Bearing Indicator</li> <li>11. Omni Course Indicators</li> <li>12. Transponder</li> <li>13. Magnetic Compass</li> <li>14. Marker Beacon Indicator Lights and Switches</li> <li>15. Rear View Mirror</li> <li>16. Audio Control Panel</li> <li>17. Radios</li> <li>18. Autopilot Control Unit</li> <li>19. Wing Flap Position Indicator</li> <li>20. Additional Instrument Space</li> <li>21. ADF Radio</li> <li>22. Flight Hour Recorder</li> </ol> | <ol style="list-style-type: none"> <li>23. Additional Radio Space</li> <li>24. Map Compartment</li> <li>25. Cabin Heat Control Knob</li> <li>26. Cabin Air Control Knob</li> <li>27. Cigar Lighter</li> <li>28. Wing Flap Switch</li> <li>29. Mixture Control Knob</li> <li>30. Throttle (With Friction Lock)</li> <li>31. Static Pressure Alternate Source Valve</li> <li>32. Instrument and Radio Dial</li> <li>33. Light Rheostats</li> <li>34. Microphone</li> <li>35. Fuel Selector Valve Handle</li> <li>36. Elevator Trim Control Wheel</li> <li>37. Carburetor Heat Control Knob</li> <li>38. Electrical Switches</li> <li>39. Circuit Breakers</li> <li>40. Parking Brake Handle</li> <li>41. Ignition Switch</li> <li>42. Master Switch</li> <li>43. Auxiliary Mike Jack</li> <li>44. Primer</li> </ol> |
|---|---|

Figure 7-2. Instrument Panel (Sheet 2 of 2)

bellcrank, left upper and lower "V" type corrugated skins, and right upper and lower "V" type corrugated skins incorporating a trailing edge cut-out for the trim tab. The elevator trim tab consists of a spar, rib, and upper and lower "V" type corrugated skins. The leading edge of both left and right elevator tips incorporate extensions which contain balance weights.

## FLIGHT CONTROLS

The airplane's flight control system consists of conventional aileron, rudder, and elevator control surfaces (see figure 7-1). The control surfaces are manually operated through mechanical linkage using a control wheel for the ailerons and elevator, and rudder/brake pedals for the rudder.

### TRIM SYSTEM

A manually-operated elevator trim tab is provided. Elevator trimming is accomplished through the elevator trim tab by utilizing the vertically mounted trim control wheel. Upward rotation of the trim wheel will trim nose-down; conversely, downward rotation will trim nose-up.

## INSTRUMENT PANEL

The instrument panel (see figure 7-2) is designed around the basic "T" configuration. The gyros are located immediately in front of the pilot, and arranged vertically over the control column. The airspeed indicator and altimeter are located to the left and right of the gyros, respectively. The remainder of the flight instruments are located around the basic "T". Engine instruments and fuel quantity indicators are near the left edge of the panel. Avionics equipment is stacked approximately on the centerline of the panel, with the right side of the panel containing the map compartment, wing flap position indicator, space for additional instruments and avionics equipment, and cabin heat and air controls. The wing flap switch and engine controls are below the avionics equipment, and the electrical switches and circuit breakers are located below the pilot's control wheel. A master switch, ignition switch, and primer are located on the lower left corner of the panel. A pedestal is installed below the panel and contains the elevator trim tab control wheel and indicator, and provides a bracket for the microphone. The fuel selector valve handle is located at the base of the pedestal. A parking brake handle is located below the instrument panel in front of the pilot.

For details concerning the instruments, switches, circuit breakers,

and controls on this panel, refer in this section to the description of the systems to which these items are related.

## GROUND CONTROL

Effective ground control while taxiing is accomplished through nose wheel steering by using the rudder pedals; left rudder pedal to steer left and right rudder pedal to steer right. When a rudder pedal is depressed, a spring-loaded steering bungee (which is connected to the nose gear and to the rudder bars) will turn the nose wheel through an arc of approximately 10° each side of center. By applying either left or right brake, the degree of turn may be increased up to 30° each side of center.

Moving the airplane by hand is most easily accomplished by attaching a tow bar to the nose gear strut. If a tow bar is not available, or pushing is required, use the wing struts as push points. Do not use the vertical or horizontal surfaces to move the airplane. If the airplane is to be towed by vehicle, never turn the nose wheel more than 30° either side of center or structural damage to the nose gear could result.

The minimum turning radius of the airplane, using differential braking and nose wheel steering during taxi, is approximately 27 feet 5 1/2 inches. To obtain a minimum radius turn during ground handling, the airplane may be rotated around either main landing gear by pressing down on a tailcone bulkhead just forward of the horizontal stabilizer to raise the nose wheel off the ground.

## WING FLAP SYSTEM

The wing flaps are of the single-slot type (see figure 7-3) and are electrically operated by a motor located in the right wing. Flap position is controlled by a switch, labeled WING FLAPS, on the lower center portion of the instrument panel. Flap position is electrically indicated by a wing flap position indicator on the right side of the panel.

To extend the wing flaps, the flap switch, which is spring-loaded to the center, or off, position, must be depressed and held in the DOWN position until the desired degree of extension is reached. Normal full flap extension in flight will require approximately 9 seconds. After the flaps reach maximum extension or retraction, limit switches will automatically shut off the flap motor.

To retract the flaps, place the flap switch in the UP position. The switch will remain in the UP position without manual assistance due to a

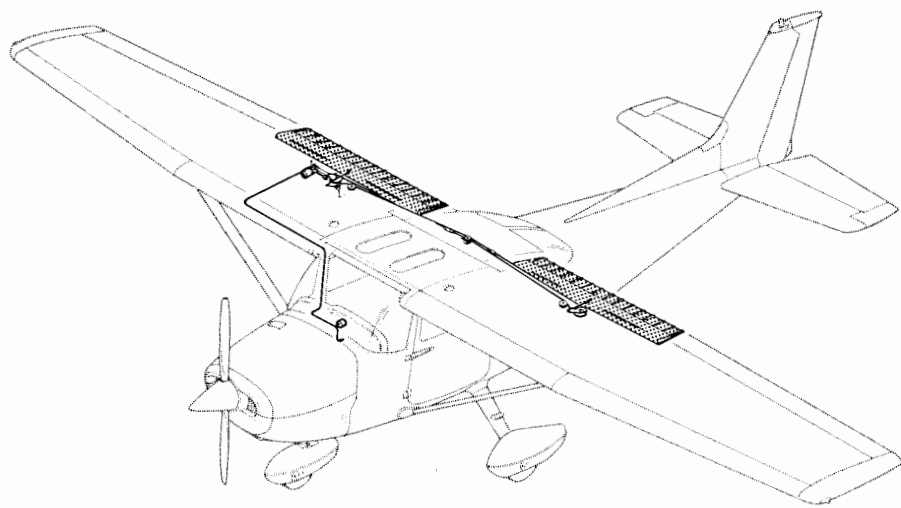

Figure 7-3. Wing Flap System

detent in the switch. Full flap retraction in flight requires approximately 7 seconds. More gradual flap retraction can be accomplished by intermittent operation of the flap switch to the UP position. After full retraction, the switch should be returned to the center off position.

## LANDING GEAR SYSTEM

The landing gear is of the tricycle type with a steerable nose wheel, two main wheels, and wheel fairings. Shock absorption is provided by the tubular spring-steel main landing gear struts and the air/oil nose gear shock strut. Each main gear wheel is equipped with a hydraulically actuated disc-type brake on the inboard side of each wheel, and an aerodynamic fairing over each brake.

## BAGGAGE COMPARTMENT

The baggage compartment consists of two areas, one extending from the back of the rear passenger seats to the aft cabin bulkhead, and an additional area aft of the bulkhead. Access to both baggage areas is gained through a lockable baggage door on the left side of the airplane, or from within the airplane cabin. A baggage net with eight tie-down straps is pro-

vided for securing baggage and is attached by tying the straps to tie-down rings provided in the airplane. When loading the airplane, children should not be placed or permitted in the baggage compartment, unless a child's seat is installed, and any material that might be hazardous to the airplane or occupants should not be placed anywhere in the airplane. For baggage area and door dimensions, refer to Section 6.

## SEATS

The seating arrangement consists of two separate adjustable seats for the pilot and front passenger, a split-backed fixed seat in the rear, and a child's seat (if installed) aft of the rear seats. The pilot's and front passenger's seats are available in two different designs: four-way and six-way adjustable.

Four-way seats may be moved forward or aft, and the seat back angle changed. To position either seat, lift the tubular handle under the center of the seat, slide the seat into position, release the handle, and check that the seat is locked in place. The seat back is spring-loaded to the vertical position. To adjust its position, lift the lever under the right front corner of the seat, reposition the back, release the lever, and check that the back is locked in place. The seat backs will also fold full forward.

The six-way seats may be moved forward or aft, adjusted for height, and the seat back angle is infinitely adjustable. Position the seat by lifting the tubular handle, under the center of the seat bottom, and slide the seat into position; then release the lever and check that the seat is locked in place. Raise or lower the seat by rotating a large crank under the right corner of the left seat and the left corner of the right seat. Seat back angle is adjustable by rotating a small crank under the left corner of the left seat and the right corner of the right seat. The seat bottom angle will change as the seat back angle changes, providing proper support. The seat backs will also fold full forward.

The rear passenger's seats consist of a fixed one-piece seat bottom with individually adjustable seat backs. Two adjustment levers, under the left and right corners of the seat bottom, are used to adjust the angle of the respective seat backs. To adjust either seat back, lift the adjustment lever and reposition the back. The seat backs are spring-loaded to the vertical position.

A child's seat may be installed aft of the rear passenger seats, and is held in place by two brackets mounted on the floorboard. The seat is designed to swing upward into a stowed position against the aft cabin bulkhead when not in use. To stow the seat, rotate the seat bottom up and aft



as far as it will go. When not in use, the seat should be stowed.

Headrests are available for any of the seat configurations except the child's seat. To adjust the headrest, apply enough pressure to it to raise or lower it to the desired level. The headrest may be removed at any time by raising it until it disengages from the top of the seat back.

## SEAT BELTS AND SHOULDER HARNESSSES

All seat positions are equipped with seat belts (see figure 7-4). The pilot's and front passenger's seats are also equipped with separate shoulder harnesses; shoulder harnesses are available for the rear seat positions. Integrated seat belt/shoulder harnesses with inertia reels can be furnished for the pilot's and front passenger's seat positions, if desired.

### SEAT BELTS

The seat belts at all seat positions are attached to fittings on the floor-board. The belt (and attaching shoulder harness) configuration will differ between early and later airplanes. In early airplanes, the buckle half of the seat belt is outboard of each seat and is the adjustable part of the belt; the link half of the belt is inboard and has a fixed length. In later airplanes, the buckle half of the seat belt is inboard of each seat and has a fixed length; the link half of the belt is outboard and is the adjustable part of the belt.

Regardless of which belt configuration is installed in the airplane, they are used in a similar manner. To use the seat belts for the front seats, position the seat as desired, and then lengthen the adjustable half of the belt as needed. Insert and lock the belt link into the buckle. Tighten the belt to a snug fit by pulling the free end of the belt. Seat belts for the rear seats, and the child's seat (if installed), are used in the same manner as the belts for the front seats. To release the seat belts, grasp the top of the buckle opposite the link and pull upward.

### SHOULDER HARNESSSES

The configuration of shoulder harnesses will differ between early and later airplanes. However, both configurations are positioned in the airplane and stowed identically. Each front seat shoulder harness is attached to a rear doorpost above the window line and is stowed behind a stowage sheath above the cabin door. To stow the harness, fold it and place it behind the sheath. When rear seat shoulder harnesses are furnished, they are attached adjacent to the lower corners of the rear window. Each rear seat harness is stowed behind a stowage sheath above an aft side win-

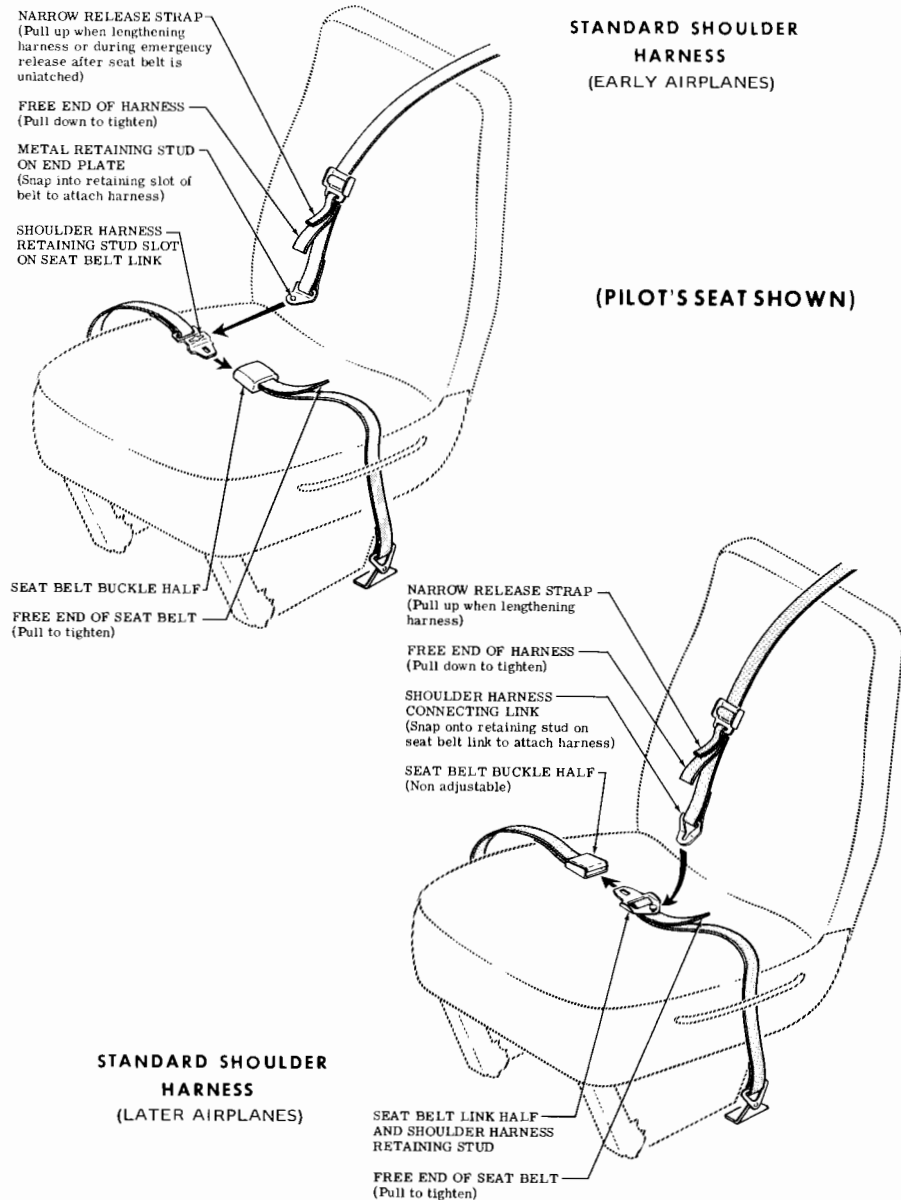

Figure 7-4. Seat Belts and Shoulder Harnesses (Sheet 1 of 2)



dow. No harness is available for the child's seat.

In early airplanes, the front or rear seat shoulder harnesses are used by fastening and adjusting the seat belt first. Then, lengthen the harness as required by pulling on the end plate of the harness and the narrow release strap. Snap the harness metal stud firmly into the retaining slot adjacent to the seat belt buckle. Then adjust to length. Removing the shoulder harness is accomplished by pulling upward on the narrow release strap, and removing the harness stud from the slot in the seat belt link. In an emergency, the shoulder harness may be removed by releasing the seat belt first, and then pulling the harness over the head by pulling up on the narrow release strap.

In later airplanes, the front or rear seat shoulder harnesses are used by fastening and adjusting the seat belt first. Then, lengthen the harness as required by pulling on the connecting link on the end of the harness and the narrow release strap. Snap the connecting link firmly onto the retaining stud on the seat belt link half. Then adjust to length. Removing the harness is accomplished by pulling upward on the narrow release strap,

and removing the harness connecting link from the stud on the seat belt link. In an emergency, the shoulder harness may be removed by releasing the seat belt first and allowing the harness, still attached to the link half of the seat belt, to drop to the side of the seat.

While wearing either configuration of shoulder harness, adjustment of the harness is important. A properly adjusted harness will permit the occupant to lean forward enough to sit completely erect, but prevent excessive forward movement and contact with objects during sudden deceleration. Also, the pilot will want the freedom to reach all controls easily.

#### INTEGRATED SEAT BELT / SHOULDER HARNESSES WITH INERTIA REELS

Integrated seat belt/shoulder harnesses with inertia reels are available for the pilot and front seat passenger. The seat belt/shoulder harnesses extend from inertia reels located in the cabin ceiling to attach points inboard of the two front seats. A separate seat belt half and buckle is located outboard of the seats. Inertia reels allow complete freedom of body movement. However, in the event of a sudden deceleration, they will lock automatically to protect the occupants.

#### NOTE

The inertia reels are located for maximum shoulder harness comfort and safe retention of the seat occupants. This location requires that the shoulder harnesses cross near the top so that the right hand inertia reel serves the pilot and the left hand reel serves the front passenger. When fastening the harness, check to ensure the proper harness is being used.

To use the seat belt/shoulder harness, position the adjustable metal link on the harness just below shoulder level, pull the link and harness downward, and insert the link into the seat belt buckle. Adjust belt tension across the lap by pulling upward on the shoulder harness. Removal is accomplished by releasing the seat belt buckle, which will allow the inertia reel to pull the harness inboard of the seat.

#### ENTRANCE DOORS AND CABIN WINDOWS

Entry to, and exit from the airplane is accomplished through either of two entry doors, one on each side of the cabin at the front seat positions (refer to Section 6 for cabin and cabin door dimensions). The doors incorporate a recessed exterior door handle, a conventional interior door handle, a key-operated door lock (left door only), a door stop mechanism,

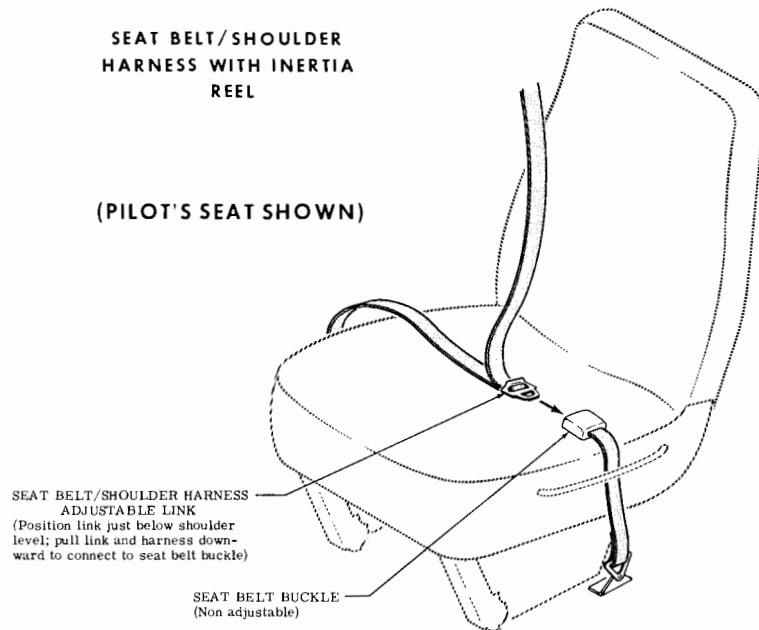

Figure 7-4. Seat Belts and Shoulder Harnesses (Sheet 2 of 2)

and an openable window in the left door. An openable right door window is also available.

To open the doors from outside the airplane, utilize the recessed door handle near the aft edge of either door by grasping the forward edge of the handle and pulling outboard. To close or open the doors from inside the airplane, use the combination door handle and arm rest. The inside door handle has three positions and a placard at its base which reads OPEN, CLOSE, and LOCK. The handle is spring-loaded to the CLOSE (up) position. When the door has been pulled shut and latched, lock it by rotating the door handle forward to the LOCK position (flush with the arm rest). When the handle is rotated to the LOCK position, an over-center action will hold it in that position.

#### NOTE

Accidental opening of a cabin door in flight due to improper closing does not constitute a need to land the airplane. The best procedure is to set up the airplane in a trimmed condition at approximately 75 knots, momentarily shove the door outward slightly, and forcefully close and lock the door by normal procedures.

Exit from the airplane is accomplished by rotating the door handle from the LOCK position, past the CLOSE position, aft to the OPEN position and pushing the door open. To lock the airplane, lock the right cabin door with the inside handle, close the left cabin door, and using the ignition key, lock the door.

The left cabin door is equipped with an openable window which is held in the closed position by a lock button equipped over-center latch on the lower edge of the window frame. To open the window, depress the lock button and rotate the latch upward. The window is equipped with a spring-loaded retaining arm which will help rotate the window outward and hold it there. An openable window is also available for the right door, and functions in the same manner as the left window. If required, either window may be opened at any speed up to 160 knots. The cabin top windows (if installed), rear side windows, and rear windows are of the fixed type and cannot be opened.

## CONTROL LOCKS

A control lock is provided to lock the ailerons and elevator control surfaces in a neutral position and prevent damage to these systems by wind buffeting while the airplane is parked. The lock consists of a shaped

steel rod with a red metal flag attached to it. The flag is labeled CONTROL LOCK, REMOVE BEFORE STARTING ENGINE. To install the control lock, align the hole in the top of the pilot's control wheel shaft with the hole in the top of the shaft collar on the instrument panel and insert the rod into the aligned holes. Proper installation of the lock will place the red flag over the ignition switch. In areas where high or gusty winds occur, a control surface lock should be installed over the vertical stabilizer and rudder. The control lock and any other type of locking device should be removed prior to starting the engine.

## ENGINE

The airplane is powered by a horizontally-opposed, four-cylinder, overhead-valve, air-cooled, carbureted engine with a wet sump oil system. The engine is a Lycoming Model O-320-E2D and is rated at 150 horsepower at 2700 RPM. The engine should develop a static RPM of approximately 2300 to 2420 RPM at full throttle with the carburetor heat off. Major accessories include a starter and belt-driven alternator mounted on the front of the engine, and dual magnetos and a vacuum pump which are mounted on an accessory drive pad on the rear of the engine. Provisions are also made for a full flow oil filter.

## ENGINE CONTROLS

Engine power is controlled by a throttle located on the lower center portion of the instrument panel. The throttle operates in a conventional manner; in the full forward position, the throttle is open, and in the full aft position, it is closed. A friction lock, which is a round knurled disk, is located at the base of the throttle and is operated by rotating the lock clockwise to increase friction or counterclockwise to decrease it.

The mixture control, mounted adjacent to the throttle, is a red knob with raised points around the circumference and is equipped with a lock button in the end of the knob. The rich position is full forward, and full aft is the idle cut-off position. To adjust the mixture, move the control forward or aft by depressing the lock button in the end of the control.

## ENGINE INSTRUMENTS

Engine operation is monitored by the following instruments: oil pressure gage, oil temperature gage, and a tachometer.

The oil pressure gage, located on the left side of the instrument panel, is operated by oil pressure. A direct pressure oil line from the engine delivers oil at engine operating pressure to the oil pressure gage. Gage

markings indicate that minimum idling pressure is 25 PSI (red line), the normal operating range is 60 to 90 PSI (green arc), and maximum pressure is 100 PSI (red line).

Oil temperature is indicated by a gage adjacent to the oil pressure gage. The gage is operated by an electrical-resistance type temperature sensor which receives power from the airplane electrical system. Oil temperature limitations are the normal operating range (green arc) which is 38°C (100°F) to 118°C (245°F), and the maximum (red line) which is 118°C (245°F).

The engine-driven mechanical tachometer is located near the lower portion of the instrument panel to the left of the pilot's control wheel. The instrument is calibrated in increments of 100 RPM and indicates both engine and propeller speed. An hour meter below the center of the tachometer dial records elapsed engine time in hours and tenths. Instrument markings include a normal operating range (stepped green arc) of 2200 to 2700 RPM with steps at the 2500 and 2600 RPM indicator marks. The normal operating range upper limit is 2500 RPM at sea level, and increases to 2600 RPM at 5000 feet and 2700 RPM at 10,000 feet. Maximum (red line) at any altitude is 2700 RPM.

A carburetor air temperature gage may be installed on the right side of the instrument panel to help detect carburetor icing conditions. The gage is marked in 5° increments from -30°C to +30°C, and has a yellow arc between -15°C and +5°C which indicates the temperature range most conducive to icing in the carburetor. A placard on the lower half of the gage face reads KEEP NEEDLE OUT OF YELLOW ARC DURING POSSIBLE CARBURETOR ICING CONDITIONS.

## NEW ENGINE BREAK-IN AND OPERATION

The engine underwent a run-in at the factory and is ready for the full range of use. It is, however, suggested that cruising be accomplished at 65% to 75% power until a total of 50 hours has accumulated or oil consumption has stabilized. This will ensure proper seating of the rings.

The airplane is delivered from the factory with corrosion preventive oil in the engine. If, during the first 25 hours, oil must be added, use only aviation grade straight mineral oil conforming to Specification No. MIL-L-6082.

## ENGINE OIL SYSTEM

Oil for engine lubrication is supplied from a sump on the bottom of the engine. The capacity of the engine sump is eight quarts (one additional

quart is required if a full flow oil filter is installed). Oil is drawn from the sump through an oil suction strainer screen into the engine-driven oil pump. From the pump, oil is routed to a bypass valve. If the oil is cold, the bypass valve allows the oil to go directly from the pump to the oil filter. If the oil is hot, the bypass valve routes the oil out of the accessory housing and into a flexible hose leading to the oil cooler on the lower right side of the firewall. Pressure oil from the cooler returns to the accessory housing where it passes through the pressure strainer screen (full flow oil filter, if installed). The filtered oil then enters a pressure relief valve which regulates engine oil pressure by allowing excessive oil to return to the sump, while the balance of the pressure oil is circulated to various engine parts for lubrication. Residual oil is returned to the sump by gravity flow.

An oil filler cap/oil dipstick is located at the rear of the engine on the right side. The filler cap/dipstick is accessible through an access door in the engine cowling. The engine should not be operated on less than six quarts of oil. To minimize loss of oil through the breather, fill to seven quarts for normal flights of less than three hours. For extended flight, fill to eight quarts (dipstick indication only). For engine oil grade and specifications, refer to Section 8 of this handbook.

An oil quick-drain valve is available to replace the drain plug on the bottom left side of the oil sump, and provides quicker, cleaner draining of the engine oil. To drain the oil with this valve, slip a hose over the end of the valve and push upward on the end of the valve until it snaps into the open position. Spring clips will hold the valve open. After draining, use a suitable tool to snap the valve into the extended (closed) position and remove the drain hose.

## IGNITION-STARTER SYSTEM

Engine ignition is provided by two engine-driven magnetos, and two spark plugs in each cylinder. The right magneto fires the lower right and upper left spark plugs, and the left magneto fires the lower left and upper right spark plugs. Normal operation is conducted with both magnetos due to the more complete burning of the fuel-air mixture with dual ignition.

Ignition and starter operation is controlled by a rotary type switch located on the left switch and control panel. The switch is labeled clockwise, OFF, R, L, BOTH, and START. The engine should be operated on both magnetos (BOTH position) except for magneto checks. The R and L positions are for checking purposes and emergency use only. When the switch is rotated to the spring-loaded START position, (with the master switch in the ON position), the starter contactor is energized and the start-

er will crank the engine. When the switch is released, it will automatically return to the BOTH position.

### AIR INDUCTION SYSTEM

The engine air induction system receives ram air through an intake in the lower front portion of the engine cowling. The intake is covered by an air filter which removes dust and other foreign matter from the induction air. Airflow passing through the filter enters an airbox at the front of the engine. After passing through the airbox, induction air enters the inlet in the carburetor which is under the engine, and is then ducted to the engine cylinders through intake manifold tubes. In the event carburetor ice is encountered or the intake filter becomes blocked, alternate heated air can be obtained from a shroud around an exhaust riser through a duct to a valve, in the airbox, operated by the carburetor heat control on the instrument panel. Heated air from the shroud is obtained from an unfiltered outside source. Use of full carburetor heat at full throttle will result in a loss of approximately 100 to 225 RPM.

### EXHAUST SYSTEM

Exhaust gas from each cylinder passes through riser assemblies to a muffler and tailpipe. The muffler is constructed with a shroud around the outside which forms a heating chamber for cabin heater air.

### CARBURETOR AND PRIMING SYSTEM

The engine is equipped with an up-draft, float-type, fixed jet carburetor mounted on the bottom of the engine. The carburetor is equipped with an enclosed accelerator pump, simplified fuel passages to prevent vapor locking, an idle cut-off mechanism, and a manual mixture control. Fuel is delivered to the carburetor by gravity flow from the fuel system. In the carburetor, fuel is atomized, proportionally mixed with intake air, and delivered to the cylinders through intake manifold tubes. The proportion of atomized fuel to air is controlled, within limits, by the mixture control on the instrument panel.

For easy starting in cold weather, the engine is equipped with a manual primer. The primer is actually a small pump which draws fuel from the fuel strainer when the plunger is pulled out, and injects it into the cylinder intake ports when the plunger is pushed back in. The plunger knob, on the instrument panel, is equipped with a lock and, after being pushed full in, must be rotated either left or right until the knob cannot be pulled out.

### COOLING SYSTEM

Ram air for engine cooling enters through two intake openings in the front of the engine cowling. The cooling air is directed around the cylinders and other areas of the engine by baffling, and is then exhausted through an opening at the bottom aft edge of the cowling. No manual cooling system control is provided.

A winterization kit is available and consists of two baffles which attach to the air intakes in the cowling nose cap, a restrictive cover plate for the oil cooler air inlet in the right rear vertical engine baffle, and insulation for the crankcase breather line. This equipment should be installed for operations in temperatures consistently below  $-7^{\circ}\text{C}$  ( $20^{\circ}\text{F}$ ). Once installed, the crankcase breather insulation is approved for permanent use in both hot and cold weather.

### PROPELLER

The airplane is equipped with a two-bladed, fixed-pitch, one-piece forged aluminum alloy propeller which is anodized to retard corrosion. The propeller is 75 inches in diameter.

### FUEL SYSTEM

The airplane may be equipped with either a standard fuel system or a long range system (see figure 7-6). Both systems consist of two vented fuel tanks (one in each wing), a four-position selector valve, fuel strainer, manual primer, and carburetor. Refer to figure 7-5 for fuel quantity data for both systems.

Fuel flows by gravity from the two wing tanks to a four-position selec-

FUEL QUANTITY DATA (U. S. GALLONS)			
TANKS	TOTAL USABLE FUEL ALL FLIGHT CONDITIONS	TOTAL UNUSABLE FUEL	TOTAL FUEL VOLUME
STANDARD (21 Gal. Each)	38	4	42
LONG RANGE (26 Gal. Each)	48	4	52

Figure 7-5. Fuel Quantity Data

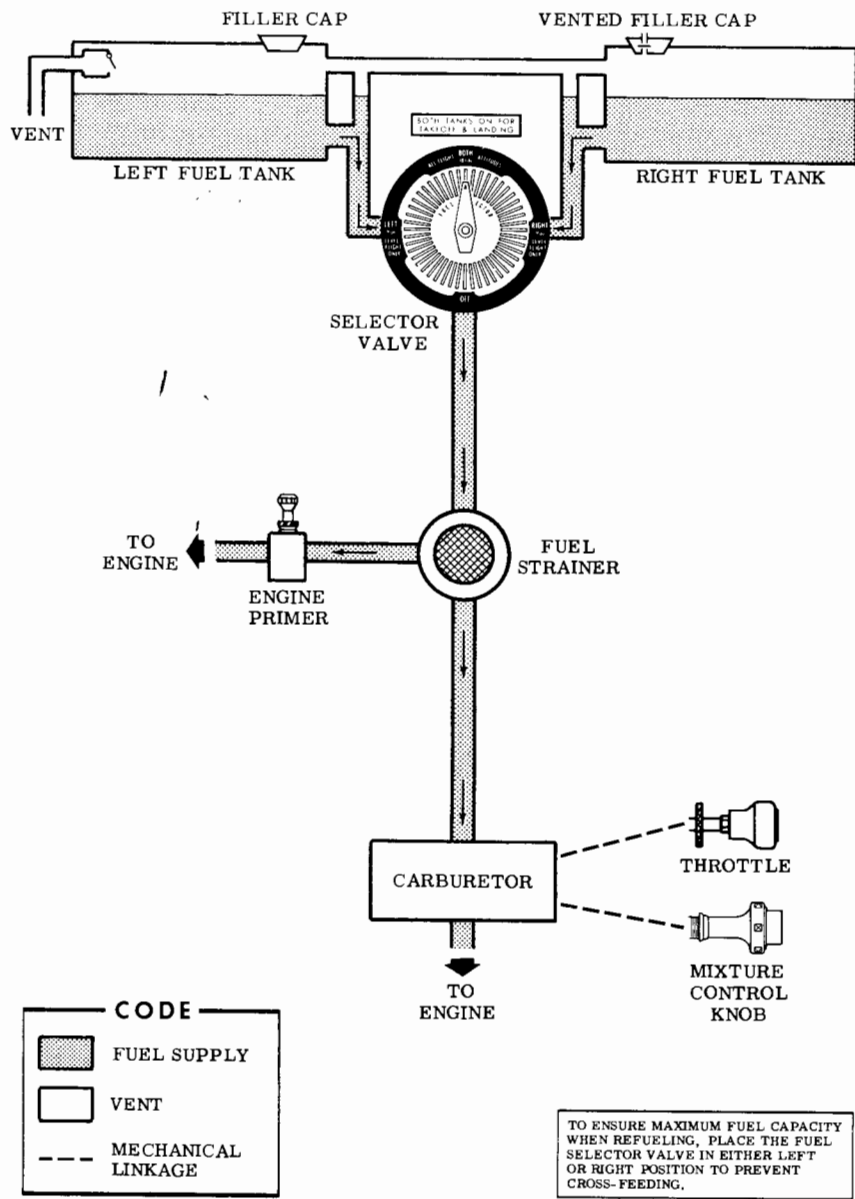

Figure 7-6. Fuel System (Standard and Long Range)

tor valve, labeled BOTH, RIGHT, LEFT, and OFF. With the selector valve in either the BOTH, LEFT, or RIGHT position, fuel flows through a strainer to the carburetor. From the carburetor, mixed fuel and air flows to the cylinders through intake manifold tubes. The manual primer draws its fuel from the fuel strainer and injects it into the cylinder intake ports.

Fuel system venting is essential to system operation. Blockage of the system will result in decreasing fuel flow and eventual engine stoppage. Venting is accomplished by an interconnecting line from the right fuel tank to the left tank. The left fuel tank is vented overboard through a vent line, equipped with a check valve, which protrudes from the bottom surface of the left wing near the wing strut. The right fuel tank filler cap is also vented.

Fuel quantity is measured by two float-type fuel quantity transmitters (one in each tank) and indicated by two electrically-operated fuel quantity indicators on the left side of the instrument panel. An empty tank is indicated by a red line and the letter E. When an indicator shows an empty tank, approximately 2 gallons remain in a standard tank, and 2 gallons remain in a long range tank as unusable fuel. The indicators cannot be relied upon for accurate readings during skids, slips, or unusual attitudes.

The fuel selector valve should be in the BOTH position for takeoff, climb, landing, and maneuvers that involve prolonged slips or skids. Operation from either LEFT or RIGHT tank is reserved for cruising flight.

NOTE

With low fuel (1/8th tank or less), a prolonged steep descent (1500 feet or more) with partial power, full flaps, and 70 KIAS or greater should be avoided due to the possibility of the fuel tank outlets being uncovered, causing temporary fuel starvation. If starvation occurs, leveling the nose should restore power within 20 seconds.

NOTE

When the fuel selector valve handle is in the BOTH position in cruising flight, unequal fuel flow from each tank may occur if the wings are not maintained exactly level. Resulting wing heaviness can be alleviated gradually by turning the selector valve handle to the tank in the "heavy" wing.

NOTE

It is not practical to measure the time required to consume all of the fuel in one tank, and, after switching to the opposite tank, expect an equal duration from the remaining fuel. The airspace in both fuel tanks is inter-

connected by a vent line and, therefore, some sloshing of fuel between tanks can be expected when the tanks are nearly full and the wings are not level.

The fuel system is equipped with drain valves to provide a means for the examination of fuel in the system for contamination and grade. The system should be examined before the first flight of every day and after each refueling, by using the sampler cup provided to drain fuel from the wing tank sumps, and by utilizing the fuel strainer drain under an access panel on the right side of the engine cowling. The fuel tanks should be filled after each flight to prevent condensation.

### BRAKE SYSTEM

The airplane has a single-disc, hydraulically-actuated brake on each main landing gear wheel. Each brake is connected, by a hydraulic line, to a master cylinder attached to each of the pilot's rudder pedals. The brakes are operated by applying pressure to the top of either the left (pilot's) or right (copilot's) set of rudder pedals, which are interconnected. When the airplane is parked, both main wheel brakes may be set by utilizing the parking brake which is operated by a handle under the left side of the instrument panel. To apply the parking brake, set the brakes with the rudder pedals, pull the handle aft, and rotate it 90° down.

For maximum brake life, keep the brake systems properly maintained, and minimize brake usage during taxi operations and landings.

Some of the symptoms of impending brake failure are: gradual decrease in braking action after brake application, noisy or dragging brakes, soft or spongy pedals, short pedal travel and hard pedal, and excessive travel and weak braking action. If any of these symptoms appear, the brake system is in need of immediate attention. If, during taxi or landing roll, braking action decreases, let up on the pedals and then re-apply the brakes with heavy pressure. If the brakes become spongy or pedal travel increases, pumping the pedals should build braking pressure. If one brake becomes weak or fails, use the other brake sparingly while using opposite rudder, as required, to offset the good brake.

### ELECTRICAL SYSTEM

Electrical energy (see figure 7-7) is supplied by a 14-volt, direct-current system powered by an engine-driven, 60-amp alternator. The 12-volt, 25-amp hour battery is located on the left side of the firewall. Power is supplied to all electrical circuits through a split bus bar, one side containing electronic system circuits and the other side having general electrical system circuits. Both sides of the bus are on at all times

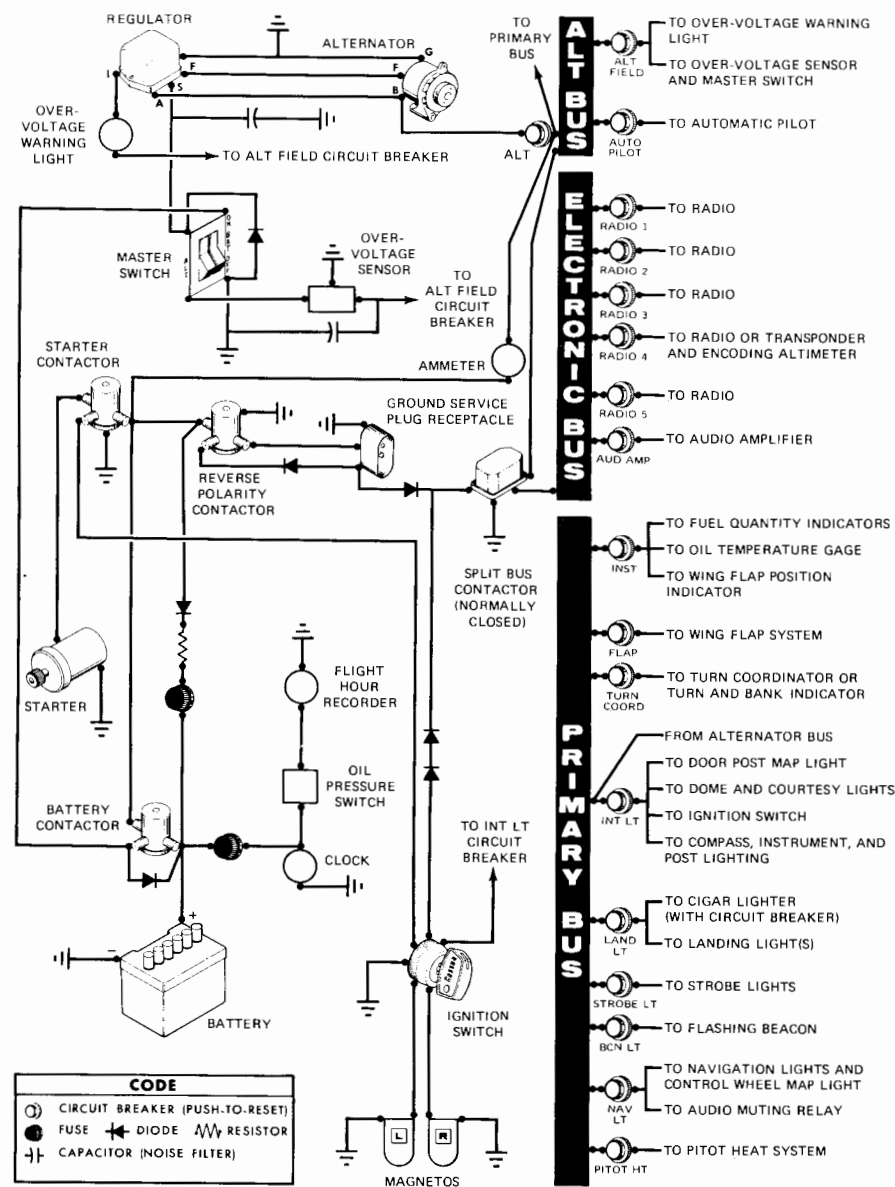

Figure 7-7. Electrical System



except when either an external power source is connected or the starter switch is turned on; then a power contactor is automatically activated to open the circuit to the electronic bus. Isolating the electronic circuits in this manner prevents harmful transient voltages from damaging the transistors in the electronic equipment.

### MASTER SWITCH

The master switch is a split-rocker type switch labeled MASTER, and is ON in the up position and OFF in the down position. The right half of the switch, labeled BAT, controls all electrical power to the airplane. The left half, labeled ALT, controls the alternator.

Normally, both sides of the master switch should be used simultaneously; however, the BAT side of the switch could be turned ON separately to check equipment while on the ground. The ALT side of the switch, when placed in the OFF position, removes the alternator from the electrical system. With this switch in the OFF position, the entire electrical load is placed on the battery. Continued operation with the alternator switch in the OFF position will reduce battery power low enough to open the battery contactor, remove power from the alternator field, and prevent alternator restart.

### AMMETER

The ammeter indicates the flow of current, in amperes, from the alternator to the battery or from the battery to the airplane electrical system. When the engine is operating and the master switch is turned on, the ammeter indicates the charging rate applied to the battery. In the event the alternator is not functioning or the electrical load exceeds the output of the alternator, the ammeter indicates the battery discharge rate.

### OVER-VOLTAGE SENSOR AND WARNING LIGHT

The airplane is equipped with an automatic over-voltage protection system consisting of an over-voltage sensor behind the instrument panel and a red warning light, labeled HIGH VOLTAGE, adjacent to the ammeter.

In the event an over-voltage condition occurs, the over-voltage sensor automatically removes alternator field current and shuts down the alternator. The red warning light will then turn on, indicating to the pilot that the alternator is not operating and the battery is supplying all electrical power.

The over-voltage sensor may be reset by turning the master switch off and back on again. If the warning light does not illuminate, normal

alternator charging has resumed; however, if the light does illuminate again, a malfunction has occurred, and the flight should be terminated as soon as practical.

The warning light may be tested by momentarily turning off the ALT portion of the master switch and leaving the BAT portion turned on.

### CIRCUIT BREAKERS AND FUSES

Most of the electrical circuits in the airplane are protected by "push-to-reset" circuit breakers mounted on the left side of the instrument panel. Exceptions to this are the battery contactor closing (external power) circuit, clock, and flight hour recorder circuits which have fuses mounted near the battery. The control wheel map light is protected by the NAV LT circuit breaker on the instrument panel, and a fuse behind the panel. The cigar lighter is protected by a manually reset circuit breaker on the back of the lighter, and by the LAND LT circuit breaker.

### GROUND SERVICE PLUG RECEPTACLE

A ground service plug receptacle may be installed to permit the use of an external power source for cold weather starting and during lengthy maintenance work on the airplane electrical system (with the exception of electronic equipment). The receptacle is located behind a door on the left side of the fuselage near the aft edge of the cowling.

#### NOTE

Electrical power for the airplane electrical circuits is provided through a split bus bar having all electronic circuits on one side of the bus and other electrical circuits on the other side of the bus. When an external power source is connected, a contactor automatically opens the circuit to the electronic portion of the split bus bar as a protection against damage to the transistors in the electronic equipment by transient voltages from the power source. Therefore, the external power source can not be used as a source of power when checking electronic components.

Just before connecting an external power source (generator type or battery cart), the master switch should be turned on.

The ground service plug receptacle circuit incorporates a polarity reversal protection. Power from the external power source will flow only if the ground service plug is correctly connected to the airplane. If the plug is accidentally connected backwards, no power will flow to the electrical system, thereby preventing any damage to electrical equipment.

The battery and external power circuits have been designed to completely eliminate the need to "jumper" across the battery contactor to close it for charging a completely "dead" battery. A special fused circuit in the external power system supplies the needed "jumper" across the contacts so that with a "dead" battery and an external power source applied, turning on the master switch will close the battery contactor.

## LIGHTING SYSTEMS

### EXTERIOR LIGHTING

Conventional navigation lights are located on the wing tips and top of the rudder. A single landing light or dual landing/taxi lights are installed in the cowl nose cap, and a flashing beacon is mounted on top of the vertical fin. Additional lighting is available and includes a strobe light on each wing tip and two courtesy lights, one under each wing, just outboard of the cabin door. The courtesy lights are operated by the dome light switch on the overhead console. All exterior lights, except the courtesy lights, are controlled by rocker type switches on the left switch and control panel. The switches are ON in the up position and OFF in the down position.

The flashing beacon should not be used when flying through clouds or overcast; the flashing light reflected from water droplets or particles in the atmosphere, particularly at night, can produce vertigo and loss of orientation.

The two high intensity strobe lights will enhance anti-collision protection. However, the lights should be turned off when taxiing in the vicinity of other aircraft, or during night flight through clouds, fog or haze.

### INTERIOR LIGHTING

Instrument and control panel lighting is provided by flood lighting, integral lighting, and post lighting (if installed). Two concentric rheostat control knobs below the engine controls, labeled PANEL LT and RADIO LT, control intensity of the instrument and control panel lighting. A slide-type switch (if installed) on the overhead console, labeled PANEL LTS, is used to select flood lighting in the FLOOD position, post lighting in the POST position, or a combination of post and flood lighting in the BOTH position.

Instrument and control panel flood lighting consists of a single red flood light in the forward part of the overhead console. To use the flood lighting, rotate the PANEL LT rheostat control knob clockwise to the desired intensity.

The instrument panel may be equipped with post lights which are

mounted at the edge of each instrument or control and provide direct lighting. The lights are operated by placing the PANEL LTS selector switch in the POST position and adjusting light intensity with the PANEL LT rheostat control knob. By placing the PANEL LTS selector switch in the BOTH position, the post lights can be used in combination with the standard flood lighting.

The engine instruments, fuel quantity indicators, radio equipment, and magnetic compass have integral lighting and operate independently of post or flood lighting. Light intensity of the engine instruments, fuel quantity indicators, and radio lighting is controlled by the RADIO LT rheostat control knob. The integral compass light intensity is controlled by the PANEL LT rheostat control knob.

A cabin dome light, in the aft part of the overhead console, is operated by a switch near the light. To turn the light on, move the switch to the right.

A control wheel map light is available and is mounted on the bottom of the pilot's control wheel. The light illuminates the lower portion of the cabin just forward of the pilot and is helpful when checking maps and other flight data during night operations. To operate the light, first turn on the NAV LT switch; then adjust the map light's intensity with the knurled disk type rheostat control located at the bottom of the control wheel.

A doorpost map light is available, and is near the top of the left forward doorpost. It contains both red and white bulbs and may be positioned to illuminate any area desired by the pilot. The light is controlled by a switch, below the light, which is labeled RED, OFF, and WHITE. Placing the switch in the top position will provide a red light. In the bottom position, standard white lighting is provided. In the center position, the map light is turned off.

The most probable cause of a light failure is a burned out bulb; however, in the event any of the lighting systems fail to illuminate when turned on, check the appropriate circuit breaker. If the circuit breaker has opened (white button popped out), and there is no obvious indication of a short circuit (smoke or odor), turn off the light switch of the affected lights, reset the breaker, and turn the switch on again. If the breaker opens again, do not reset it.

## CABIN HEATING, VENTILATING AND DEFROSTING SYSTEM

The temperature and volume of airflow into the cabin can be regulated to any degree desired by manipulation of the push-pull CABIN HT and



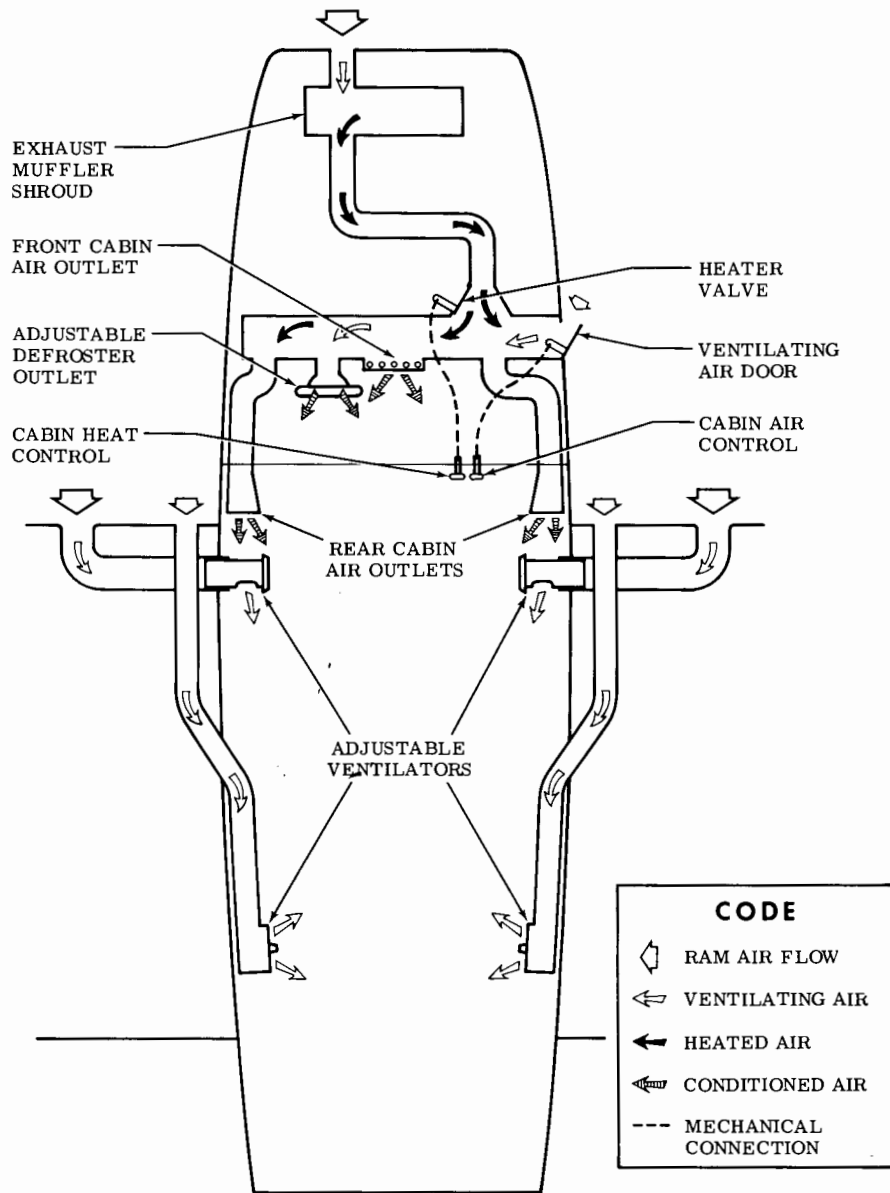

Figure 7-8. Cabin Heating, Ventilating, and Defrosting System

CABIN AIR control knobs (see figure 7-8).

For cabin ventilation, pull the CABIN AIR knob out. To raise the air temperature, pull the CABIN HT knob out approximately 1/4 to 1/2 inch for a small amount of cabin heat. Additional heat is available by pulling the knob out farther; maximum heat is available with the CABIN HT knob pulled out and the CABIN AIR knob pushed full in. When no heat is desired in the cabin, the CABIN HT knob is pushed full in.

Front cabin heat and ventilating air is supplied by outlet holes spaced across a cabin manifold just forward of the pilot's and copilot's feet. Rear cabin heat and air is supplied by two ducts from the manifold, one extending down each side of the cabin to an outlet at the front door post at floor level. Windshield defrost air is also supplied by a duct leading from the cabin manifold. Two knobs control sliding valves in the defroster outlet and permit regulation of defroster airflow.

Separate adjustable ventilators supply additional air; one near each upper corner of the windshield supplies air for the pilot and copilot, and two ventilators are available for the rear cabin area to supply air to the rear seat passengers.

## PITOT-STATIC SYSTEM AND INSTRUMENTS

The pitot-static system supplies ram air pressure to the airspeed indicator and static pressure to the airspeed indicator, rate-of-climb indicator and altimeter. The system is composed of either an unheated or heated pitot tube mounted on the lower surface of the left wing, an external static port, on the lower left side of the fuselage, and the associated plumbing necessary to connect the instruments to the sources.

The heated pitot system consists of a heating element in the pitot tube, a rocker-type switch labeled PITOT HT on the lower left side of the instrument panel, a 10-amp circuit breaker on the switch and control panel, and associated wiring. When the pitot heat switch is turned on, the element in the pitot tube is heated electrically to maintain proper operation in possible icing conditions. Pitot heat should be used only as required.

A static pressure alternate source valve may be installed adjacent to the throttle for use when the external static source is malfunctioning. This valve supplies static pressure from inside the cabin instead of the external static port.

If erroneous instrument readings are suspected due to water or ice in the pressure line going to the standard external static pressure source, the alternate static source valve should be pulled on.

Pressures within the cabin will vary with open cabin ventilators and windows. Refer to Sections 3 and 5 for the effect of varying cabin pressures on airspeed and altimeter readings.

### AIRSPEED INDICATOR

The airspeed indicator is calibrated in knots and miles per hour. Limitation and range markings include the white arc (41 to 85 knots), green arc (47 to 128 knots), yellow arc (128 to 160 knots), and a red line (160 knots).

If a true airspeed indicator is installed, it is equipped with a rotatable ring which works in conjunction with the airspeed indicator dial in a manner similar to the operation of a flight computer. To operate the indicator, first rotate the ring until pressure altitude is aligned with outside air temperature in degrees Fahrenheit. Pressure altitude should not be confused with indicated altitude. To obtain pressure altitude, momentarily set the barometric scale on the altimeter to 29.92 and read pressure altitude on the altimeter. Be sure to return the altimeter barometric scale to the original barometric setting after pressure altitude has been obtained. Having set the ring to correct for altitude and temperature, then read the airspeed shown on the rotatable ring by the indicator pointer. For best accuracy, this indication should be corrected to calibrated airspeed by referring to the Airspeed Calibration chart in Section 5. Knowing the calibrated airspeed, read true airspeed on the ring opposite the calibrated airspeed.

### RATE-OF-CLIMB INDICATOR

The rate-of-climb indicator depicts airplane rate of climb or descent in feet per minute. The pointer is actuated by an atmospheric pressure change supplied by the static source.

### ALTIMETER

Airplane altitude is depicted by a barometric type altimeter. A knob near the lower left portion of the indicator provides adjustment of the instrument's barometric scale to the proper barometric pressure reading.

## VACUUM SYSTEM AND INSTRUMENTS

An engine-driven vacuum system (see figure 7-9) provides the suction necessary to operate the attitude indicator and directional indicator. The system consists of a vacuum pump mounted on the engine, a vacuum relief valve and vacuum system air filter on the aft side of the firewall below the instrument panel, and instruments (including a suction gage) on

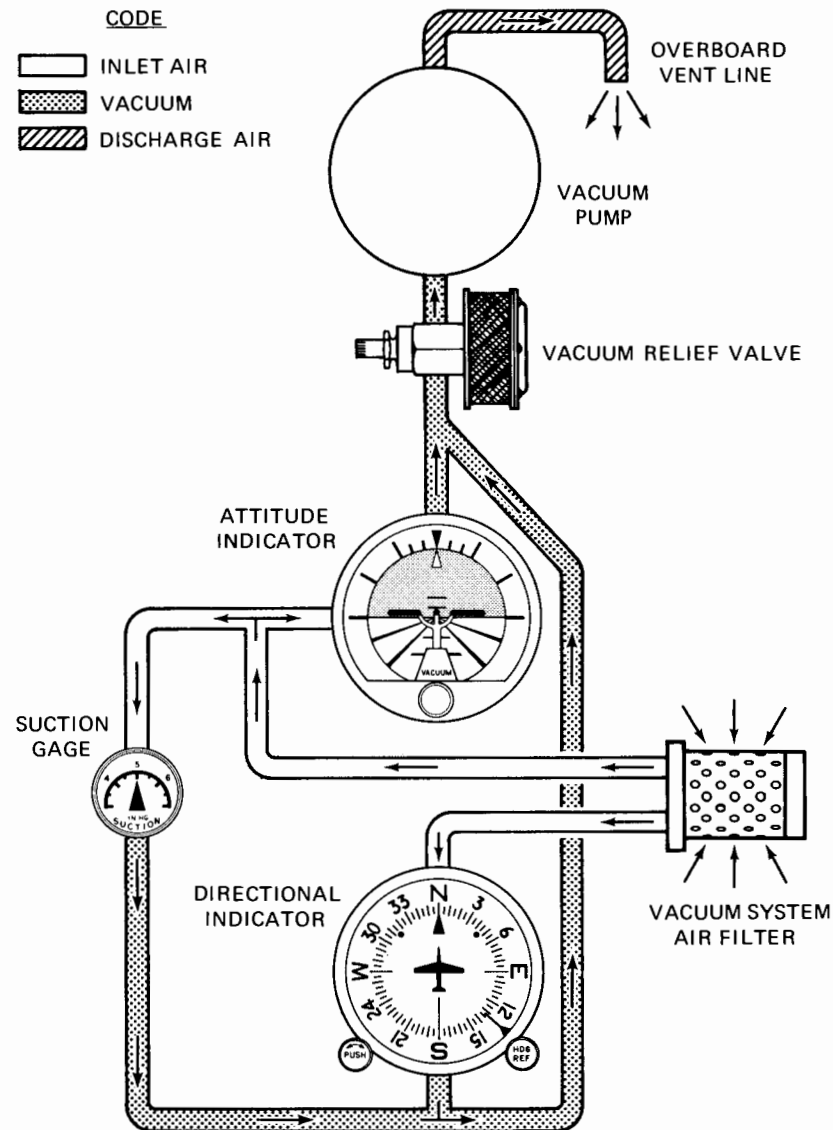

Figure 7-9. Vacuum System

the left side of the instrument panel.

### ATTITUDE INDICATOR

The attitude indicator gives a visual indication of flight attitude. Bank attitude is presented by a pointer at the top of the indicator relative to the bank scale which is marked in increments of 10°, 20°, 30°, 60°, and 90° either side of the center mark. Pitch attitude is presented by a miniature airplane in relation to the horizon bar. A knob at the bottom of the instrument is provided for in-flight adjustment of the miniature airplane to the horizon bar for a more accurate flight attitude indication.

### DIRECTIONAL INDICATOR

A directional indicator displays airplane heading on a compass card in relation to a fixed simulated airplane image and index. The indicator will precess slightly over a period of time. Therefore, the compass card should be set in accordance with the magnetic compass just prior to takeoff, and occasionally re-adjusted on extended flights. A knob on the lower left edge of the instrument is used to adjust the compass card to correct for precession.

### SUCTION GAGE

The suction gage is located on the left side of the instrument panel and indicates, in inches of mercury, the amount of suction available for operation of the attitude indicator and directional indicator. The desired suction range is 4.6 to 5.4 inches of mercury. A suction reading below this range may indicate a system malfunction or improper adjustment, and in this case, the indicators should not be considered reliable.

### STALL WARNING SYSTEM

The airplane is equipped with a pneumatic-type stall warning system consisting of an inlet in the leading edge of the left wing, an air-operated horn near the upper left corner of the windshield, and associated plumbing. As the airplane approaches a stall, a low pressure condition is created over the leading edge of the wings. This low pressure creates a differential pressure (vacuum) in the stall warning system which draws air through the warning horn, resulting in an audible warning at 5 to 10 knots above stall in all flight conditions.

The stall warning system should be checked during the preflight inspection by placing a clean handkerchief over the vent opening and applying suction. A sound from the warning horn will confirm that the system

is operative.

### AVIONICS SUPPORT EQUIPMENT

The airplane may, at the owner's discretion, be equipped with various types of avionics support equipment such as an audio control panel, microphone-headset, and static dischargers. The following paragraphs discuss these items.

### AUDIO CONTROL PANEL

Operation of radio equipment is covered in Section 9 of this handbook. When one or more radios are installed, a transmitter/audio switching system is provided (see figure 7-10). The operation of this switching system is described in the following paragraphs.

### TRANSMITTER SELECTOR SWITCH

A rotary type transmitter selector switch, labeled XMTR SEL, is provided to connect the microphone to the transmitter the pilot desires to use. To select a transmitter, rotate the switch to the number corresponding to that transmitter. The numbers 1, 2 and 3 above the switch correspond to the top, second and third transceivers in the avionics stack.

An audio amplifier is required for speaker operation, and is automatically selected, along with the transmitter, by the transmitter selector switch. As an example, if the number 1 transmitter is selected, the audio amplifier in the associated NAV/COM receiver is also selected, and functions as the amplifier for ALL speaker audio. In the event the audio amplifier in use fails, as evidenced by loss of all speaker audio, select another transmitter. This should re-establish speaker audio. Headset audio is not affected by audio amplifier operation.

### AUTOMATIC AUDIO SELECTOR SWITCH

A toggle switch, labeled AUTO, can be used to automatically match the appropriate NAV/COM receiver audio to the transmitter being selected. To utilize this automatic feature, leave all NAV/COM receiver switches in the OFF (center) position, and place the AUTO selector switch in either the SPEAKER or PHONE position, as desired. Once the AUTO selector switch is positioned, the pilot may then select any transmitter and its associated NAV/COM receiver audio simultaneously with the transmitter selector switch. If automatic audio selection is not desired, the AUTO selector switch should be placed in the OFF (center) position.

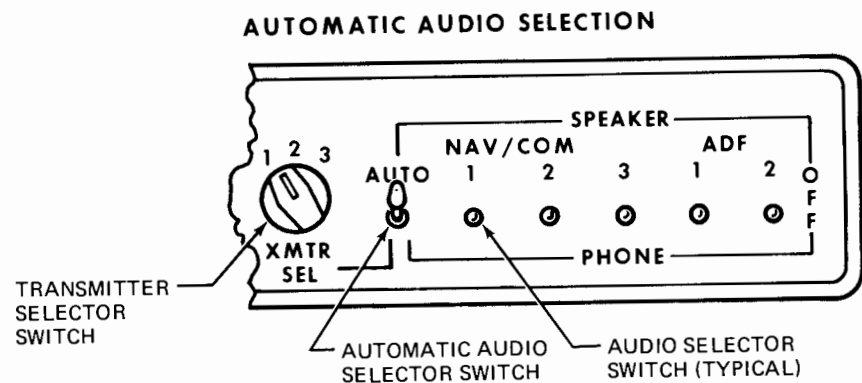

As illustrated, the number 1 transmitter is selected, the AUTO selector switch is in the SPEAKER position, and the NAV/COM 1, 2 and 3 and ADF 1 and 2 audio selector switches are in the OFF position. With the switches set as shown, the pilot will transmit on the number 1 transmitter and hear the number 1 NAV/COM receiver through the airplane speaker.

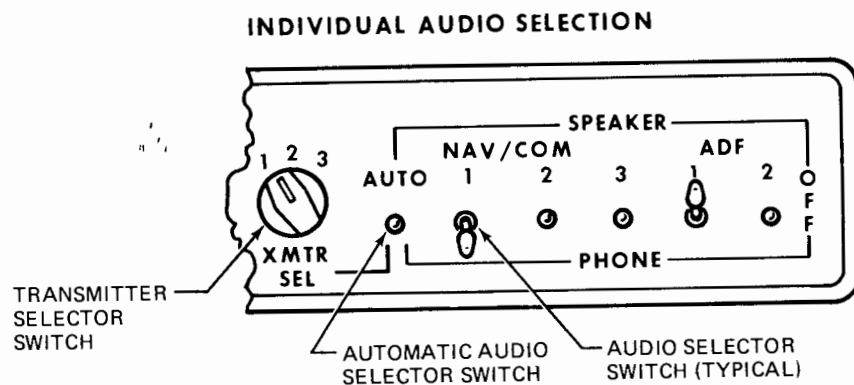

As illustrated, the number 1 transmitter is selected, the AUTO selector switch is in the OFF position, the number 1 NAV/COM receiver is in the PHONE position, and the number 1 ADF is in the SPEAKER position. With the switches set as shown, the pilot will transmit on the number 1 transmitter and hear the number 1 NAV/COM receiver on a headset, while the passengers are listening to the ADF audio through the airplane speaker. If another audio selector switch is placed in either the PHONE or SPEAKER position, it will be heard simultaneously with either the number 1 NAV/COM or number 1 ADF respectively.

Figure 7-10. Audio Control Panel

### AUDIO SELECTOR SWITCHES

The audio selector switches, labeled NAV/COM 1, 2 and 3 and ADF 1 and 2, allow the pilot to initially pre-tune all NAV/COM and ADF receivers, and then individually select and listen to any receiver or combination of receivers. To listen to a specific receiver, first check that the AUTO selector switch is in the OFF (center) position, then place the audio selector switch corresponding to that receiver in either the SPEAKER (up) or PHONE (down) position. To turn off the audio of the selected receiver, place that switch in the OFF (center) position. If desired, the audio selector switches can be positioned to permit the pilot to listen to one receiver on a headset while the passengers listen to another receiver on the airplane speaker.

The ADF 1 and 2 switches may be used anytime ADF audio is desired. If the pilot wants only ADF audio, for station identification or other reasons, the AUTO selector switch (if in use) and all other audio selector switches should be in the OFF position. If simultaneous ADF and NAV/COM audio is acceptable to the pilot, no change in the existing switch positions is required. Place the ADF 1 or 2 switch in either the SPEAKER or PHONE position and adjust radio volume as desired.

#### NOTE

If the NAV/COM audio selector switch corresponding to the selected transmitter is in the PHONE position with the AUTO selector switch in the SPEAKER position, all audio selector switches placed in the PHONE position will automatically be connected to both the airplane speaker and any headsets in use.

### MICROPHONE-HEADSET

The microphone-headset combination consists of the microphone and headset combined in a single unit and a microphone keying switch located on the left side of the pilot's control wheel. The microphone-headset permits the pilot to conduct radio communications without interrupting other control operations to handle a hand-held microphone. Also, passengers need not listen to all communications. The microphone and headset jacks are located near the lower left corner of the instrument panel.

### STATIC DISCHARGERS

If frequent IFR flights are planned, installation of wick-type static dischargers is recommended to improve radio communications during flight

through dust or various forms of precipitation (rain, freezing rain, snow or ice crystals). Under these conditions, the build-up and discharge of static electricity from the trailing edges of the wings, rudder, elevator, propeller tips and radio antennas can result in loss of usable radio signals on all communications and navigation radio equipment. Usually the ADF is first to be affected and VHF communication equipment is the last to be affected.

Installation of static dischargers reduces interference from precipitation static, but it is possible to encounter severe precipitation static conditions which might cause the loss of radio signals, even with static dischargers installed. Whenever possible, avoid known severe precipitation areas to prevent loss of dependable radio signals. If avoidance is impractical, minimize airspeed and anticipate temporary loss of radio signals while in these areas.

# SECTION 8 AIRPLANE HANDLING, SERVICE & MAINTENANCE

## TABLE OF CONTENTS

	Page
Introduction . . . . .	8-3
Identification Plate . . . . .	8-3
Owner Follow-Up System . . . . .	8-3
Publications . . . . .	8-3
Airplane File . . . . .	8-4
Airplane Inspection Periods . . . . .	8-5
FAA Required Inspections . . . . .	8-5
Cessna Progressive Care . . . . .	8-6
Cessna Customer Care Program . . . . .	8-6
Pilot Conducted Preventive Maintenance . . . . .	8-7
Alterations or Repairs . . . . .	8-7
Ground Handling . . . . .	8-7
Towing . . . . .	8-7
Parking . . . . .	8-8
Tie-Down . . . . .	8-8
Jacking . . . . .	8-8
Leveling . . . . .	8-9
Flyable Storage . . . . .	8-9
Servicing . . . . .	8-10
Engine Oil . . . . .	8-10
Fuel . . . . .	8-11
Landing Gear . . . . .	8-12
Cleaning and Care . . . . .	8-12
Windshield-Windows . . . . .	8-12
Painted Surfaces . . . . .	8-12
Propeller Care . . . . .	8-13
Engine Care . . . . .	8-13
Interior Care . . . . .	8-14

## INTRODUCTION

This section contains factory-recommended procedures for proper ground handling and routine care and servicing of your Cessna. It also identifies certain inspection and maintenance requirements which must be followed if your airplane is to retain that new-plane performance and dependability. It is wise to follow a planned schedule of lubrication and preventive maintenance based on climatic and flying conditions encountered in your locality.

Keep in touch with your Cessna Dealer and take advantage of his knowledge and experience. He knows your airplane and how to maintain it. He will remind you when lubrications and oil changes are necessary, and about other seasonal and periodic services.

## IDENTIFICATION PLATE

All correspondence regarding your airplane should include the SERIAL NUMBER. The Serial Number, Model Number, Production Certificate Number (PC) and Type Certificate Number (TC) can be found on the Identification Plate, located on the lower part of the left forward door-post. Located adjacent to the Identification Plate is a Finish and Trim Plate which contains a code describing the interior color scheme and exterior paint combination of the airplane. The code may be used in conjunction with an applicable Parts Catalog if finish and trim information is needed.

## OWNER FOLLOW-UP SYSTEM

Your Cessna Dealer has an Owner Follow-Up System to notify you when he receives information that applies to your Cessna. In addition, if you wish, you may choose to receive similar notification, in the form of Service Letters, directly from the Cessna Customer Services Department. A subscription form is supplied in your Customer Care Program book for your use, should you choose to request this service. Your Cessna Dealer will be glad to supply you with details concerning these follow-up programs, and stands ready, through his Service Department, to supply you with fast, efficient, low-cost service.

## PUBLICATIONS

Various publications and flight operation aids are furnished in the

airplane when delivered from the factory. These items are listed below.

- CUSTOMER CARE PROGRAM BOOK
- PILOT'S OPERATING HANDBOOK OR SUPPLEMENTS FOR YOUR AIRPLANE AVIONICS AND AUTOPILOT
- POWER COMPUTER
- SALES AND SERVICE DEALER DIRECTORY

The following additional publications, plus many other supplies that are applicable to your airplane, are available from your Cessna Dealer.

- SERVICE MANUALS AND PARTS CATALOGS FOR YOUR AIRPLANE ENGINE AND ACCESSORIES AVIONICS AND AUTOPILOT

Your Cessna Dealer has a Customer Care Supplies Catalog covering all available items, many of which he keeps on hand. He will be happy to place an order for any item which is not in stock.

## AIRPLANE FILE

There are miscellaneous data, information and licenses that are a part of the airplane file. The following is a checklist for that file. In addition, a periodic check should be made of the latest Federal Aviation Regulations to ensure that all data requirements are met.

A. To be displayed in the airplane at all times:

- (1) Aircraft Airworthiness Certificate (FAA Form 8100-2).
- (2) Aircraft Registration Certificate (FAA Form 8050-3).
- (3) Aircraft Radio Station License, if transmitter installed (FCC Form 556).

B. To be carried in the airplane at all times:

- (1) Weight and Balance, and associated papers (latest copy of the Repair and Alteration Form, FAA Form 337, if applicable).
- (2) Equipment List.

C. To be made available upon request:

- (1) Airplane Log Book.
- (2) Engine Log Book.

Most of the items listed are required by the United States Federal Aviation Regulations. Since the Regulations of other nations may require other documents and data, owners of airplanes not registered in the United States should check with their own aviation officials to determine their individual requirements.

Cessna recommends that these items, plus the Pilot's Operating Handbook, Power Computer, Customer Care Program book and Customer Care Card, be carried in the airplane at all times.

## AIRPLANE INSPECTION PERIODS

### FAA REQUIRED INSPECTIONS

As required by Federal Aviation Regulations, all civil aircraft of U.S. registry must undergo a complete inspection (annual) each twelve calendar months. In addition to the required ANNUAL inspection, aircraft operated commercially (for hire) must have a complete inspection every 100 hours of operation.

The FAA may require other inspections by the issuance of airworthiness directives applicable to the airplane, engine, propeller and components. It is the responsibility of the owner/operator to ensure compliance with all applicable airworthiness directives and, when the inspections are repetitive, to take appropriate steps to prevent inadvertent noncompliance.

In lieu of the 100 HOUR and ANNUAL inspection requirements, an airplane may be inspected in accordance with a progressive inspection schedule, which allows the work load to be divided into smaller operations that can be accomplished in shorter time periods.

The CESSNA PROGRESSIVE CARE PROGRAM has been developed to provide a modern progressive inspection schedule that satisfies the complete airplane inspection requirements of both the 100 HOUR and ANNUAL inspections as applicable to Cessna airplanes. The program assists the owner in his responsibility to comply with all FAA inspection requirements, while ensuring timely replacement of life-limited parts and adherence to factory-recommended inspection intervals and maintenance procedures.

### CESSNA PROGRESSIVE CARE

The Cessna Progressive Care Program has been designed to help you realize maximum utilization of your airplane at a minimum cost and downtime. Under this program, your airplane is inspected and maintained in four operations at 50-hour intervals during a 200-hour period. The operations are recycled each 200 hours and are recorded in a specially provided Aircraft Inspection Log as each operation is conducted.

The Cessna Aircraft Company recommends Progressive Care for airplanes that are being flown 200 hours or more per year, and the 100-hour inspection for all other airplanes. The procedures for the Progressive Care Program and the 100-hour inspection have been carefully worked out by the factory and are followed by the Cessna Dealer Organization. The complete familiarity of Cessna Dealers with Cessna equipment and factory-approved procedures provides the highest level of service possible at lower cost to Cessna owners.

Regardless of the inspection method selected by the owner, he should keep in mind that FAR Part 43 and FAR Part 91 establishes the requirement that properly certified agencies or personnel accomplish all required FAA inspections and most of the manufacturer recommended inspections.

### CESSNA CUSTOMER CARE PROGRAM

Specific benefits and provisions of the CESSNA WARRANTY plus other important benefits for you are contained in your CUSTOMER CARE PROGRAM book supplied with your airplane. You will want to thoroughly review your Customer Care Program book and keep it in your airplane at all times.

Coupons attached to the Program book entitle you to an initial inspection and either a Progressive Care Operation No. 1 or the first 100-hour inspection within the first 6 months of ownership at no charge to you. If you take delivery from your Dealer, the initial inspection will have been performed before delivery of the airplane to you. If you pick up your airplane at the factory, plan to take it to your Dealer reasonably soon after you take delivery, so the initial inspection may be performed allowing the Dealer to make any minor adjustments which may be necessary.

You will also want to return to your Dealer either at 50 hours for your first Progressive Care Operation, or at 100 hours for your first 100-hour inspection depending on which program you choose to establish for your airplane. While these important inspections will be performed for you by any Cessna Dealer, in most cases you will prefer to have the Dealer from whom you purchased the airplane accomplish this work.

### PILOT CONDUCTED PREVENTIVE MAINTENANCE

A certified pilot who owns or operates an airplane not used as an air carrier is authorized by FAR Part 43 to perform limited maintenance on his airplane. Refer to FAR Part 43 for a list of the specific maintenance operations which are allowed.

#### NOTE

Pilots operating airplanes of other than U.S. registry should refer to the regulations of the country of certification for information on preventive maintenance that may be performed by pilots.

A Service Manual should be obtained prior to performing any preventive maintenance to ensure that proper procedures are followed. Your Cessna Dealer should be contacted for further information or for required maintenance which must be accomplished by appropriately licensed personnel.

### ALTERATIONS OR REPAIRS

It is essential that the FAA be contacted prior to any alterations on the airplane to ensure that airworthiness of the airplane is not violated. Alterations or repairs to the airplane must be accomplished by licensed personnel.

### GROUND HANDLING

#### TOWING

The airplane is most easily and safely maneuvered by hand with the tow-bar attached to the nose wheel. When towing with a vehicle, do not exceed the nose gear turning angle of 30° either side of center, or damage to the gear will result. If the airplane is towed or pushed over a rough surface during hangaring, watch that the normal cushioning action of the nose strut does not cause excessive vertical movement of the tail and the resulting contact with low hangar doors or structure. A flat nose tire or deflated strut will also increase tail height.

#### PARKING

When parking the airplane, head into the wind and set the parking brakes. Do not set the parking brakes during cold weather when accumulated moisture may freeze the brakes, or when the brakes are overheated.



Install the control wheel lock and chock the wheels. In severe weather and high wind conditions, tie the airplane down as outlined in the following paragraph.

### TIE-DOWN

Proper tie-down procedure is the best precaution against damage to the parked airplane by gusty or strong winds. To tie-down the airplane securely, proceed as follows:

- (1) Set the parking brake and install the control wheel lock.
- (2) Install a surface control lock over the fin and rudder.
- (3) Tie sufficiently strong ropes or chains (700 pounds tensile strength) to the wing, tail, and nose tie-down fittings and secure each rope to a ramp tie-down.
- (4) Install a pitot tube cover.

### JACKING

When a requirement exists to jack the entire airplane off the ground, or when wing jack points are used in the jacking operation, refer to the Service Manual for specific procedures and equipment required.

Individual main gear may be jacked by using the jack pad which is incorporated in the main landing gear strut step bracket. When using the individual gear strut jack pad, flexibility of the gear strut will cause the main wheel to slide inboard as the wheel is raised, tilting the jack. The jack must then be lowered for a second jacking operation. Do not jack both main wheels simultaneously using the individual main gear jack pads.

If nose gear maintenance is required, the nose wheel may be raised off the ground by pressing down on a tailcone bulkhead, just forward of the horizontal stabilizer, and allowing the tail to rest on the tail tie-down ring.

#### NOTE

Do not apply pressure on the elevator or outboard stabilizer surfaces. When pushing on the tailcone, always apply pressure at a bulkhead to avoid buckling the skin.

To assist in raising and holding the nose wheel off the ground, weight down the tail by placing sand-bags, or suitable weights, on each side of the horizontal stabilizer, next to the fuselage. If ground anchors are

available, the tail should be securely tied down.

#### NOTE

Ensure that the nose will be held off the ground under all conditions by means of suitable stands or supports under weight supporting bulkheads near the nose of the airplane.

### LEVELING

Longitudinal leveling of the airplane is accomplished by placing a level on leveling screws located on the left side of the tailcone. Deflate the nose tire and/or lower or raise the nose strut to properly center the bubble in the level. Corresponding points on both upper door sills may be used to level the airplane laterally.

### FLYABLE STORAGE

Airplanes placed in non-operational storage for a maximum of 30 days or those which receive only intermittent operational use for the first 25 hours are considered in flyable storage status. Every seventh day during these periods, the propeller should be rotated by hand through five revolutions. This action "limbers" the oil and prevents any accumulation of corrosion on engine cylinder walls.

#### **WARNING**

For maximum safety, check that the ignition switch is OFF, the throttle is closed, the mixture control is in the idle cut-off position, and the airplane is secured before rotating the propeller by hand. Do not stand within the arc of the propeller blades while turning the propeller.

After 30 days, the airplane should be flown for 30 minutes or a ground runup should be made just long enough to produce an oil temperature within the lower green arc range. Excessive ground runup should be avoided.

Engine runup also helps to eliminate excessive accumulations of water in the fuel system and other air spaces in the engine. Keep fuel tanks full to minimize condensation in the tanks. Keep the battery fully charged to prevent the electrolyte from freezing in cold weather. If the airplane is to be stored temporarily, or indefinitely, refer to the Service Manual for proper storage procedures.

## SERVICING

In addition to the PREFLIGHT INSPECTION covered in Section 4, COMPLETE servicing, inspection, and test requirements for your airplane are detailed in the Service Manual. The Service Manual outlines all items which require attention at 50, 100, and 200 hour intervals plus those items which require servicing, inspection, and/or testing at special intervals.

Since Cessna Dealers conduct all service, inspection, and test procedures in accordance with applicable Service Manuals, it is recommended that you contact your Cessna Dealer concerning these requirements and begin scheduling your airplane for service at the recommended intervals.

Cessna Progressive Care ensures that these requirements are accomplished at the required intervals to comply with the 100-hour or ANNUAL inspection as previously covered.

Depending on various flight operations, your local Government Aviation Agency may require additional service, inspections, or tests. For these regulatory requirements, owners should check with local aviation officials where the airplane is being operated.

For quick and ready reference, quantities, materials, and specifications for frequently used service items are as follows.

### ENGINE OIL

GRADE -- Aviation Grade SAE 50 Above 16°C (60°F).

Aviation Grade SAE 10W30 or SAE 30 Between -18°C (0°F) and 21°C (70°F).

Aviation Grade SAE 10W30 or SAE 20 Below -12°C (10°F).

Multi-viscosity oil with a range of SAE 10W30 is recommended for improved starting in cold weather. Ashless dispersant oil, conforming to Specification No. MIL-L-22851, must be used.

#### NOTE

Your Cessna was delivered from the factory with a corrosion preventive aircraft engine oil. If oil must be added during the first 25 hours, use only aviation grade straight mineral oil conforming to Specification No. MIL-L-6082.

CAPACITY OF ENGINE SUMP -- 8 Quarts.

Do not operate on less than 6 quarts. To minimize loss of oil through

breather, fill to 7 quart level for normal flights of less than 3 hours. For extended flight, fill to 8 quarts. These quantities refer to oil dipstick level readings. During oil and oil filter changes, one additional quart is required when the filter element is changed.

### OIL AND OIL FILTER CHANGE --

After the first 25 hours of operation, drain engine oil sump and oil cooler and clean both the oil suction strainer and the oil pressure screen. If an oil filter is installed, change filter element at this time. Refill sump with straight mineral oil and use until a total of 50 hours has accumulated or oil consumption has stabilized; then change to dispersant oil. On airplanes not equipped with an oil filter, drain the engine oil sump and oil cooler and clean both the oil suction strainer and the oil pressure screen each 50 hours thereafter. On airplanes which have an oil filter, the oil change interval may be extended to 100-hour intervals, providing the oil filter element is changed at 50-hour intervals. Change engine oil at least every 6 months even though less than the recommended hours have accumulated. Reduce intervals for prolonged operation in dusty areas, cold climates, or when short flights and long idle periods result in sludging conditions.

### FUEL

GRADE (AND COLOR) -- 80/87 Minimum Grade Aviation Fuel (red).

Alternate fuels which are also approved are:

100/130 Low Lead AVGAS (green). (Maximum lead content of 2 cc per gallon.)

100/130 Aviation Grade Fuel (green). (Maximum lead content of 4.6 cc per gallon.)

#### NOTE

When substituting a higher octane fuel, low lead AVGAS 100 should be used whenever possible since it will result in less lead contamination of the engine.

CAPACITY EACH STANDARD TANK -- 21 Gallons.

CAPACITY EACH LONG RANGE TANK -- 26 Gallons.

#### NOTE

To ensure maximum fuel capacity when refueling, place the fuel selector valve in either LEFT or RIGHT position to prevent cross-feeding.

## LANDING GEAR

NOSE WHEEL TIRE PRESSURE -- 31 PSI on 5.00-5, 4-Ply Rated Tire.  
26 PSI on 6.00-6, 4-Ply Rated Tire.  
MAIN WHEEL TIRE PRESSURE -- 29 PSI on 6.00-6, 4-Ply Rated Tires.  
NOSE GEAR SHOCK STRUT --  
Keep filled with MIL-H-5606 hydraulic fluid and inflated with air to 45 PSI.

## CLEANING AND CARE

### WINDSHIELD-WINDOWS

The plastic windshield and windows should be cleaned with an aircraft windshield cleaner. Apply the cleaner sparingly with soft cloths, and rub with moderate pressure until all dirt, oil scum and bug stains are removed. Allow the cleaner to dry, then wipe it off with soft flannel cloths.

If a windshield cleaner is not available, the plastic can be cleaned with soft cloths moistened with Stoddard solvent to remove oil and grease.

#### NOTE

Never use gasoline, benzene, alcohol, acetone, carbon tetrachloride, fire extinguisher or anti-ice fluid, lacquer thinner or glass cleaner to clean the plastic. These materials will attack the plastic and may cause it to craze.

Follow by carefully washing with a mild detergent and plenty of water. Rinse thoroughly, then dry with a clean moist chamois. Do not rub the plastic with a dry cloth since this builds up an electrostatic charge which attracts dust. Waxing with a good commercial wax will finish the cleaning job. A thin, even coat of wax polished out by hand with clean soft flannel cloths, will fill in minor scratches and help prevent further scratching.

Do not use a canvas cover on the windshield unless freezing rain or sleet is anticipated since the cover may scratch the plastic surface.

### PAINTED SURFACES

The painted exterior surfaces of your new Cessna have a durable, long lasting finish and, under normal conditions, require no polishing or buffing. Approximately 15 days are required for the paint to cure completely; in most cases, the curing period will have been completed prior to delivery of the airplane. In the event that polishing or buffing is re-

quired within the curing period, it is recommended that the work be done by someone experienced in handling uncured paint. Any Cessna Dealer can accomplish this work.

Generally, the painted surfaces can be kept bright by washing with water and mild soap, followed by a rinse with water and drying with cloths or a chamois. Harsh or abrasive soaps or detergents which cause corrosion or scratches should never be used. Remove stubborn oil and grease with a cloth moistened with Stoddard solvent.

Waxing is unnecessary to keep the painted surfaces bright. However, if desired, the airplane may be waxed with a good automotive wax. A heavier coating of wax on the leading edges of the wings and tail and on the engine nose cap and propeller spinner will help reduce the abrasion encountered in these areas.

When the airplane is parked outside in cold climates and it is necessary to remove ice before flight, care should be taken to protect the painted surfaces during ice removal with chemical liquids. A 50-50 solution of isopropyl alcohol and water will satisfactorily remove ice accumulations without damaging the paint. A solution with more than 50% alcohol is harmful and should be avoided. While applying the de-icing solution, keep it away from the windshield and cabin windows since the alcohol will attack the plastic and may cause it to craze.

### PROPELLER CARE

Preflight inspection of propeller blades for nicks, and wiping them occasionally with an oily cloth to clean off grass and bug stains will assure long, trouble-free service. Small nicks on the propeller, particularly near the tips and on the leading edges, should be dressed out as soon as possible since these nicks produce stress concentrations, and if ignored, may result in cracks. Never use an alkaline cleaner on the blades; remove grease and dirt with carbon tetrachloride or Stoddard solvent.

### ENGINE CARE

The engine may be cleaned with Stoddard solvent, or equivalent, then dried thoroughly.

#### CAUTION

Particular care should be given to electrical equipment before cleaning. Cleaning fluids should not be allowed to enter magnetos, starter, alternator and the like. Protect these components before saturating the engine

with solvents. All other openings should also be covered before cleaning the engine assembly. Caustic cleaning solutions should be used cautiously and should always be properly neutralized after their use.

### INTERIOR CARE

To remove dust and loose dirt from the upholstery and carpet, clean the interior regularly with a vacuum cleaner.

Blot up any spilled liquid promptly with cleansing tissue or rags. Don't pat the spot; press the blotting material firmly and hold it for several seconds. Continue blotting until no more liquid is taken up. Scrape off sticky materials with a dull knife, then spot-clean the area.

Oil spots may be cleaned with household spot removers, used sparingly. Before using any solvent, read the instructions on the container and test it on an obscure place on the fabric to be cleaned. Never saturate the fabric with a volatile solvent; it may damage the padding and backing materials.

Soiled upholstery and carpet may be cleaned with foam-type detergent, used according to the manufacturer's instructions. To minimize wetting the fabric, keep the foam as dry as possible and remove it with a vacuum cleaner.

If your airplane is equipped with leather seating, cleaning of the seats is accomplished using a soft cloth or sponge dipped in mild soap suds. The soap suds, used sparingly, will remove traces of dirt and grease. The soap should be removed with a clean damp cloth.

The plastic trim, headliner, instrument panel and control knobs need only be wiped off with a damp cloth. Oil and grease on the control wheel and control knobs can be removed with a cloth moistened with Stoddard solvent. Volatile solvents, such as mentioned in paragraphs on care of the windshield, must never be used since they soften and craze the plastic.

# SECTION 9 SUPPLEMENTS (Optional Systems Description & Operating Procedures)

## TABLE OF CONTENTS

### Introduction

### Supplements:

Emergency Locator Transmitter (ELT) . . . . .	(4 pages)
Cessna 300 Transceiver (Type RT-524A) . . . . .	(4 pages)
Cessna 300 Nav/Com (Type RT-308C) . . . . .	(4 pages)
Cessna 300 Nav/Com (Type RT-528E-1) . . . . .	(6 pages)
Cessna 300 Nav/Com (Type RT-328T) . . . . .	(6 pages)
Cessna 300 ADF (Type R-546E) . . . . .	(6 pages)
Cessna 300 Transponder (Type RT-359A) and Optional Altitude Encoder (Type EA-401A) . . . . .	(6 pages)
DME (Type 190) . . . . .	(4 pages)
HF Transceiver (Type PT10-A) . . . . .	(4 pages)
SSB HF Transceiver (Type ASB-125) . . . . .	(4 pages)
Cessna 400 Marker Beacon (Type R-402A) . . . . .	(4 pages)
Cessna 200A Autopilot (Type AF-295B) . . . . .	(6 pages)
Cessna 300A Autopilot (Type AF-395A) . . . . .	(6 pages)

## INTRODUCTION

This section consists of a series of supplements, each covering a single optional system which may be installed in the airplane. Each supplement contains a brief description, and when applicable, operating limitations, emergency and normal procedures, and performance. Other routinely installed items of optional equipment, whose function and operational procedures do not require detailed instructions, are discussed in Section 7.

## SUPPLEMENT

# EMERGENCY LOCATOR TRANSMITTER (ELT)

## SECTION 1

### GENERAL

The ELT consists of a self-contained dual-frequency radio transmitter and battery power supply, and is activated by an impact of 5g or more as may be experienced in a crash landing. The ELT emits an omni-directional signal on the international distress frequencies of 121.5 and 243.0 MHz. (Some ELT units in export aircraft transmit only on 121.5 MHz.) General aviation and commercial aircraft, the FAA, and CAP monitor 121.5 MHz, and 243.0 MHz is monitored by the military. Following a crash landing, the ELT will provide line-of-sight transmission up to 100 miles at 10,000 feet. The duration of ELT transmissions is affected by ambient temperature. At temperatures of +21° to +54°C (+70° to +130°F), continuous transmission for 115 hours can be expected; a temperature of -40°C (-40°F) will shorten the duration to 70 hours.

The ELT is readily identified as a bright orange unit mounted behind the baggage compartment wall in the tailcone. To gain access to the unit, remove the baggage compartment wall. The ELT is operated by a control panel at the forward facing end of the unit (see figure 1).

## SECTION 2 LIMITATIONS

There is no change to the airplane limitations when this equipment is installed.

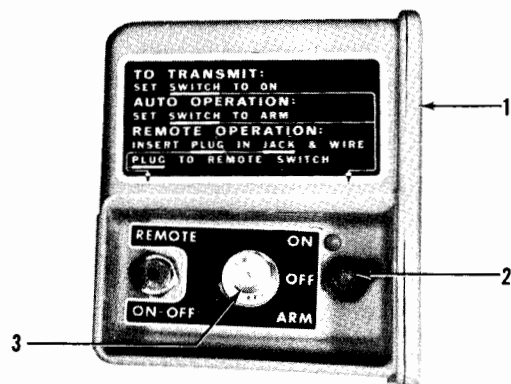

1. COVER - Removable for access to battery.
2. FUNCTION SELECTOR SWITCH (3-position toggle switch):
  - ON - Activates transmitter instantly. Used for test purposes and if "g" switch is inoperative.
  - OFF - Deactivates transmitter. Used during shipping, storage and following rescue.
  - ARM - Activates transmitter only when "g" switch receives 5g or more impact.
3. ANTENNA RECEPTACLE - Connection to antenna mounted on top of the tailcone.

Figure 1. ELT Control Panel

### SECTION 3 EMERGENCY PROCEDURES

Immediately after a forced landing where emergency assistance is required, the ELT should be utilized as follows.

- (1) ENSURE ELT ACTIVATION: Turn a radio transceiver ON and select 121.5 MHz. If the ELT can be heard transmitting, it was activated by the "g" switch and is functioning properly. If no emergency tone is audible, gain access to the ELT and place the function se-

lector switch in the ON position.

- (2) PRIOR TO SIGHTING RESCUE AIRCRAFT: Conserve airplane battery. Do not activate radio transceiver.
- (3) AFTER SIGHTING RESCUE AIRCRAFT: Place ELT function selector switch in the OFF position, preventing radio interference. Attempt contact with rescue aircraft with the radio transceiver set to a frequency of 121.5 MHz. If no contact is established, return the function selector switch to ON immediately.
- (4) FOLLOWING RESCUE: Place ELT function selector switch in the OFF position, terminating emergency transmissions.

### SECTION 4 NORMAL PROCEDURES

As long as the function selector switch remains in the ARM position, the ELT automatically activates following an impact of 5g or more over a short period of time.

Following a lightning strike, or an exceptionally hard landing, the ELT may activate although no emergency exists. To check your ELT for inadvertent activation, select 121.5 MHz on your radio transceiver and listen for an emergency tone transmission. If the ELT can be heard transmitting, place the function selector switch in the OFF position and the tone should cease. Immediately place the function selector switch in the ARM position to re-set the ELT for normal operation.

### SECTION 5 PERFORMANCE

There is no change to the airplane performance data when this equipment is installed.

## SUPPLEMENT

# CESSNA 300 TRANSCEIVER

(Type RT-524A)

### SECTION 1

#### GENERAL

The Cessna 300 Transceiver, shown in Figure 1, is a self-contained communications system capable of receiving and transmitting on any one of 360 manually tuned, crystal-controlled channels. The channels are spaced 50 kHz apart and cover a frequency range of 118.00 thru 135.95 MHz.

The 300 Transceiver system consists of a panel-mounted receiver/transmitter, a spike antenna and interconnecting cables. The system utilizes the airplane microphone, headphone and speaker.

All of the required operating controls are mounted on the front panel of the 300 Transceiver except the microphone switch. In addition, when two or more radios are installed, a transmitter selector switch and a speaker-phone selector switch are provided. Each control function is described in Figure 1.

### SECTION 2

#### LIMITATIONS

There is no change to the airplane limitations when this avionic equipment is installed.

### SECTION 3

#### EMERGENCY PROCEDURES

There is no change to the airplane emergency procedures when this avionic equipment is installed.

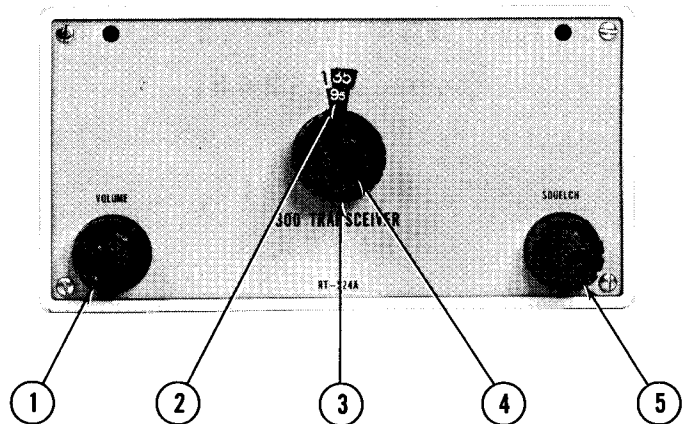

1. OFF/ON VOLUME CONTROL - Turns complete set on and controls volume of audio from receiver.
2. RECEIVER-TRANSMITTER FREQUENCY DIAL.
3. RECEIVER-TRANSMITTER FREQUENCY SELECTOR - Selects receiver-transmitter frequency in 1-MHz steps between 118.00 and 135.00 MHz.
4. RECEIVER-TRANSMITTER FRACTIONAL FREQUENCY SELECTOR - Selects receiver-transmitter fractional frequency in 0.05-MHz steps.
5. SQUELCH CONTROL - Used to adjust signal threshold necessary to activate receiver audio. Clockwise rotation increases background noise (decreases squelch action); counterclockwise rotation decreases background noise.

Figure 1. Cessna 300 Transceiver Controls

## SECTION 4 NORMAL PROCEDURES

### TO TRANSMIT:

- (1) XMTR SEL Switch -- SELECT transceiver.
- (2) Frequency Selector Knobs -- SELECT operating frequency.
- (3) Radio VOLUME Control -- ON.
- (4) Mike Button -- DEPRESS.

### TO RECEIVE:

- (1) XMTR SEL Switch -- SELECT transceiver.
- (2) SPEAKER/PHONE Switch -- SELECT desired mode.
- (3) Frequency Selector Knobs -- SELECT operating frequency.
- (4) Radio VOLUME Control -- ON and adjust to listening level.
- (5) SQUELCH Control -- ROTATE counterclockwise to decrease background noise.

## SECTION 5 PERFORMANCE

There is no change to the airplane performance when this avionic equipment is installed.



## SUPPLEMENT

### CESSNA 300 NAV/COM

(VOR Only - Type RT-308C)

#### SECTION 1

#### GENERAL

The Cessna 300 Nav/Com (Type RT-308C), shown in Figure 1, consists of a panel-mounted receiver-transmitter (RT-308C) and a single course deviation indicator (IN-514R or IN-514B). The RT-308C Receiver-Transmitter includes a 360-channel VHF communication receiver-transmitter and a 160-channel VHF navigation receiver, both of which may be operated simultaneously.

The communication receiver-transmitter receives and transmits signals between 118.00 and 135.95 MHz in 50 kHz steps. The navigation receiver receives and interprets VHF omnidirectional range (VOR) signals between 108.00 and 117.95 MHz. Although localizer signals (all odd-tenth frequencies between 108.1 and 111.9 MHz) can also be received, the navigation receiver does not include the circuits required to actuate the course deviation needle. However, the audio portion of the localizer is audible so that flight information, such as that broadcast in certain areas on selected localizer frequencies by the Automatic Terminal Information Service (ATIS), may be heard.

All controls for the Cessna 300 Nav/Com (Type RT-308C), except the omni bearing selector (OBS), are mounted on the front panel of the receiver-transmitter. The course selector and the navigation indicators are included in the course deviation indicator. The communication receiver-transmitter and the navigation receiver are synthesizer-controlled and are tuned automatically when the frequency is selected. In addition, when two or more radios are installed, a transmitter selector switch and a speaker-phone selector switch are provided. Each control function is described in Figure 1.

#### SECTION 2

#### LIMITATIONS

There is no change to the airplane limitations when this avionic equipment is installed.

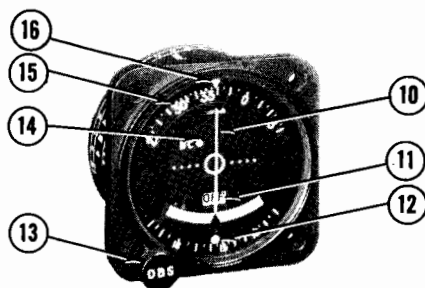
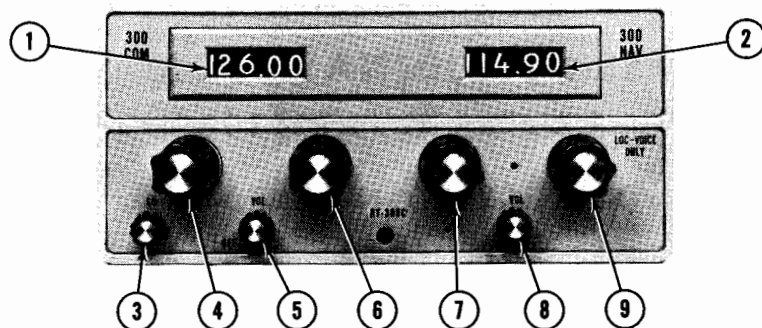

1. RECEIVER-TRANSMITTER FREQUENCY INDICATOR.
2. NAVIGATION RECEIVER FREQUENCY INDICATOR.
3. SQUELCH CONTROL - Used to adjust signal threshold necessary to activate receiver audio. Clockwise rotation increases background noise (decreases squelch action); counterclockwise rotation decreases background noise.
4. COMMUNICATION RECEIVER-TRANSMITTER MEGAHERTZ SELECTOR - Selects communication receiver-transmitter frequency in 1-MHz steps between 118 and 135 MHz.

Figure 1. Cessna 300 Nav/Com (Type RT-308C) - VOR only (Sheet 1 of 2)

5. OFF/ON VOLUME CONTROL - Turns complete set on and controls volume of audio from communication receiver.
6. COMMUNICATION RECEIVER-TRANSMITTER FRACTIONAL MEGAHERTZ SELECTOR - Selects communication receiver-transmitter fractional frequency in 0.05 MHz steps between 0.00 and 0.95 MHz.
7. NAVIGATION RECEIVER MEGAHERTZ SELECTOR - Selects navigation receiver frequency in 1-MHz steps between 108 and 117 MHz.
8. NAVIGATION RECEIVER VOLUME CONTROL - Controls volume of audio from navigation receiver only. Clockwise rotation increases audio level.
9. NAVIGATION RECEIVER FRACTIONAL MEGAHERTZ SELECTOR - Selects navigation receiver frequency in 0.05 MHz steps between 0.00 and 0.95 MHz.
10. COURSE DEVIATION POINTER - Indicates course deviation from selected omni bearing.
11. OFF/TO-FROM (OMNI) INDICATOR - Operates only with VOR signal. "OFF" position (flag) indicates unreliable signal or no signal. When "OFF" position disappears, indicator shows whether selected course is "TO" or "FROM" the station.
12. RECIPROCAL COURSE INDEX - Indicates reciprocal of selected VOR course.
13. OMNI BEARING SELECTOR (OBS) - Selects desired course to or from a VOR station.
14. BACK COURSE (BC) INDICATOR LIGHT (On IN-514B Only) - Not used with this radio.
15. BEARING DIAL.
16. COURSE INDEX - Indicates selected VOR course.

Figure 1. Cessna 300 Nav/Com (Type RT-308C) - VOR only (Sheet 2 of 2)

### SECTION 3 EMERGENCY PROCEDURES

There is no change to the airplane emergency procedures when this avionic equipment is installed.

### SECTION 4 NORMAL PROCEDURES

#### TO TRANSMIT:

- (1) XMTR SEL Switch -- SELECT transceiver.
- (2) COM Frequency Selector Knobs -- SELECT operating frequency.
- (3) OFF/VOL control -- ON.
- (4) Mike Button -- DEPRESS.

#### TO RECEIVE:

- (1) XMTR SEL Switch -- SELECT transceiver.
- (2) SPEAKER/PHONE Switch -- SELECT desired mode.
- (3) COM/NAV Frequency Selector Knobs -- SELECT frequency.
- (4) VOL Control -- ADJUST to listening level (OFF/VOL knob must be ON).
- (5) SQ Control -- ROTATE counterclockwise to decrease background noise.

### SECTION 5 PERFORMANCE

There is no change to the airplane performance when this avionic equipment is installed.

## SUPPLEMENT

### CESSNA 300 NAV/COM

#### (360-Channel - Type RT-528E-1)

### SECTION 1 GENERAL

The Cessna 300 Nav/Com (Type RT-528E-1), shown in Figure 1, consists of a panel-mounted receiver-transmitter and a single- or dual-pointer remote course indicator. The receiver-transmitters include a 360-channel VHF communication receiver-transmitter and a 200-channel VHF navigation receiver.

The communication receiver-transmitter receives and transmits signals between 118.00 and 135.95 MHz in 50 kHz steps. The navigation receiver receives and interprets VOR and localizer signals between 108.00 and 117.95 MHz in 50 kHz steps. The communication receiver-transmitter and the navigation receiver are synthesizer-controlled and are tuned automatically when the frequency is selected.

A DME receiver-transmitter or a glide slope receiver, or both, may be interconnected with the Cessna 300 Nav/Com set for automatic selection of the associated DME or GS frequency. When a VOR frequency is selected on the Nav/Com, the associated VORTAC or VOR-DME station frequency will also be selected automatically; likewise, if a localizer frequency is selected, the associated glide slope frequency will be selected automatically.

All controls of the Cessna 300 Nav/Com, except the omni bearing selector knob (OBS), which is located on the course indicator, are mounted on the front panel of the receiver-transmitter. The course indicator includes either a single pointer and related OFF flag for VOR/LOC indication only, or dual pointers and related OFF flags for both VOR/LOC and glide slope indications. The course indicator also incorporates a back-course lamp (BC) which lights when back-course operation is selected. In addition, when two or more radios are installed, a transmitter selector switch and a speaker-phone selector switch are provided. Each control function is described in Figure 1.

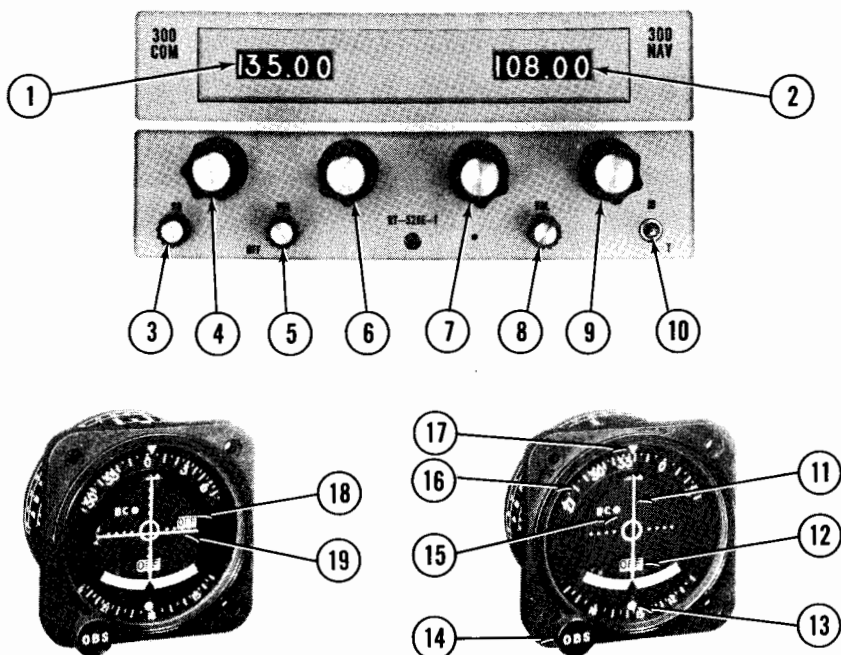

1. RECEIVER-TRANSMITTER FREQUENCY INDICATOR.
2. NAVIGATION RECEIVER FREQUENCY INDICATOR.
3. SQUELCH CONTROL - Used to adjust signal threshold necessary to activate receiver audio. Clockwise rotation increases background noise (decreases squelch action); counterclockwise rotation decreases background noise.
4. COMMUNICATION RECEIVER-TRANSMITTER MEGAHERTZ SELECTOR - Selects communication receiver-transmitter frequency in 1-MHz steps between 118 and 135 MHz.
5. OFF/ON VOLUME CONTROL - Turns complete set on and controls volume of audio from communication receiver.
6. COMMUNICATION RECEIVER-TRANSMITTER FRACTIONAL MEGAHERTZ SELECTOR - Selects communication receiver-transmitter fractional frequency in 0.05-MHz steps between 0.00 and 0.95 MHz.

Figure 1. Cessna 300 Nav/Com (Type RT-528E-1) (Sheet 1 of 2)

7. NAVIGATION RECEIVER MEGAHERTZ SELECTOR - Selects navigation receiver frequency in 1-MHz steps between 108 and 117 MHz.
8. NAVIGATION RECEIVER VOLUME CONTROL - Controls volume of audio from navigation receiver only. Clockwise rotation increases audio level.
9. NAVIGATION RECEIVER FRACTIONAL MEGAHERTZ SELECTOR - Selects navigation receiver frequency in 0.05-MHz steps between 0.00 and 0.95 MHz.
10. COMBINED IDENTIFIER SIGNAL SELECTOR AND VOR SELF-TEST SELECTOR SWITCH - When VOR station is selected in ID position, station identifier is audible; in center (unmarked) position, identifier is off; in T (momentary on) position, tests VOR navigation circuits.
11. COURSE DEVIATION POINTER - Indicates course deviation from selected omni bearing or localizer centerline.
12. OFF/TO-FROM (OMNI) INDICATOR - Operates only with VOR or localizer signal. "OFF" position (flag) indicates unreliable signal. When "OFF" position disappears, indicator shows whether selected VOR course is "TO" or "FROM" the station (if LOC frequency is selected, indicator will only show "TO").
13. RECIPROCAL COURSE INDEX - Indicates reciprocal of selected VOR course.
14. OMNI BEARING SELECTOR (OBS) - Selects desired course to or from a VOR station.
15. BC - Amber light illuminates when an optional autopilot system is installed and the autopilot's back-course button is engaged; indicates CDI needle is reversed on selected receiver when tuned to a localizer frequency (type IN-514B or IN-525B Indicators only).
16. BEARING DIAL.
17. COURSE INDEX - Indicates selected VOR course.
18. GLIDE SLOPE "OFF" FLAG - When visible, indicates unreliable glide slope signal or no glide slope signal. The flag disappears when a reliable glide slope signal is being received.
19. GLIDE SLOPE DEVIATION POINTER - Indicates deviation from normal glide slope.

Figure 1. Cessna 300 Nav/Com (Type RT-528E-1) (Sheet 2 of 2)

## SECTION 2 LIMITATIONS

There is no change to the airplane limitations when this avionic equipment is installed. However, the pilot should be aware that on many Cessna airplanes equipped with the windshield mounted glide slope antenna, pilots should avoid use of 2700 ±100 RPM (or 1800 ±100 RPM with a three bladed propeller) during ILS approaches to avoid propeller interference caused oscillations of the glide slope deviation pointer.

## SECTION 3 EMERGENCY PROCEDURES

There is no change to the airplane emergency procedures when this avionic equipment is installed.

## SECTION 4 NORMAL PROCEDURES

### TO TRANSMIT:

- (1) XMTR SEL Switch -- SELECT transceiver.
- (2) COM Frequency Selector Knobs -- SELECT operating frequency.
- (3) OFF/VOL Control -- ON.
- (4) Mike Button -- DEPRESS.

### TO RECEIVE:

- (1) XMTR SEL Switch -- SELECT transceiver.
- (2) SPEAKER/PHONE Switch -- SELECT desired mode.
- (3) COM/NAV Frequency Selector Knobs -- SELECT frequency.
- (4) VOL Control -- Adjust to listening level (OFF/VOL knob must be ON).
- (5) SQ Control -- ROTATE counterclockwise to decrease background noise.

### TO OPERATE IDENT FILTER:

- (1) ID-T Switch -- CENTER (unmarked) to include filter in audio circuit of both receivers.

- (2) ID-T Switch -- ID position disconnects filter from audio circuit to hear navigation station identifier (Morse Code) signal.

### NOTE

The ID-T switch should be left in ID position for best communications reception.

### TO SELF TEST VOR NAVIGATION CIRCUITS:

- (1) Tune to usable VOR signal from either a VOR station or a test signal.
- (2) OBS Knob -- ROTATE course index to 0°.
- (3) ID-T Switch -- T position. Vertical pointer should center and OFF-TO-FROM indicator should show FROM.
- (4) ID-T Switch -- T position and rotate OBS knob to displace course index approximately 10° to either side of 0°. Vertical pointer should deflect full scale in direction corresponding to course index displacement.
- (5) ID-T Switch -- CENTER (unmarked) position for normal VOR operation.

### NOTE

This test does not fulfill the requirements of FAR 91.25.

## SECTION 5 PERFORMANCE

There is no change to the airplane performance when this avionic equipment is installed.

## SUPPLEMENT

### CESSNA 300 NAV/COM (720-Channel - Type RT-328T)

#### SECTION 1 GENERAL

The Cessna 300 Nav/Com (Type RT-328T), shown in Figure 1, consists of a panel-mounted receiver-transmitter and a single- or dual-pointer remote course indicator. The set includes a 720-channel VHF communication receiver-transmitter and a 200-channel VHF navigation receiver, both of which may be operated simultaneously.

The communication receiver-transmitter receives and transmits signals between 118.000 and 135.975 MHz in 25-kHz steps. The navigation receiver receives and interprets VHF omnidirectional and localizer signals between 108.00 and 117.95 MHz in 50-kHz steps. The communication receiver-transmitter and the navigation receiver are synthesizer-controlled and are tuned automatically when the frequency is selected.

A DME receiver-transmitter or a glide slope receiver, or both, may be interconnected with the Cessna 300 Nav/Com set for automatic selection of the associated DME or GS frequency. When a VOR frequency is selected on the Nav/Com, the associated VORTAC or VOR-DME station frequency will also be selected automatically; likewise, if a localizer frequency is selected, the associated glide slope frequency will be selected automatically.

All controls of the Cessna 300 Nav/Com, except the omni bearing selector knob (OBS), which is located on the course indicator, are mounted on the front panel of the receiver-transmitter. The course indicator includes either a single pointer and related OFF flag for VOR/LOC indication only, or dual pointers and related OFF flags for both VOR/LOC and glide slope indications. The course indicator also incorporates a back-course lamp (BC) which lights when back-course operation is selected. In addition, when two or more radios are installed, a transmitter selector switch and a speaker-phone selector switch are provided. Each control function is described in Figure 1.

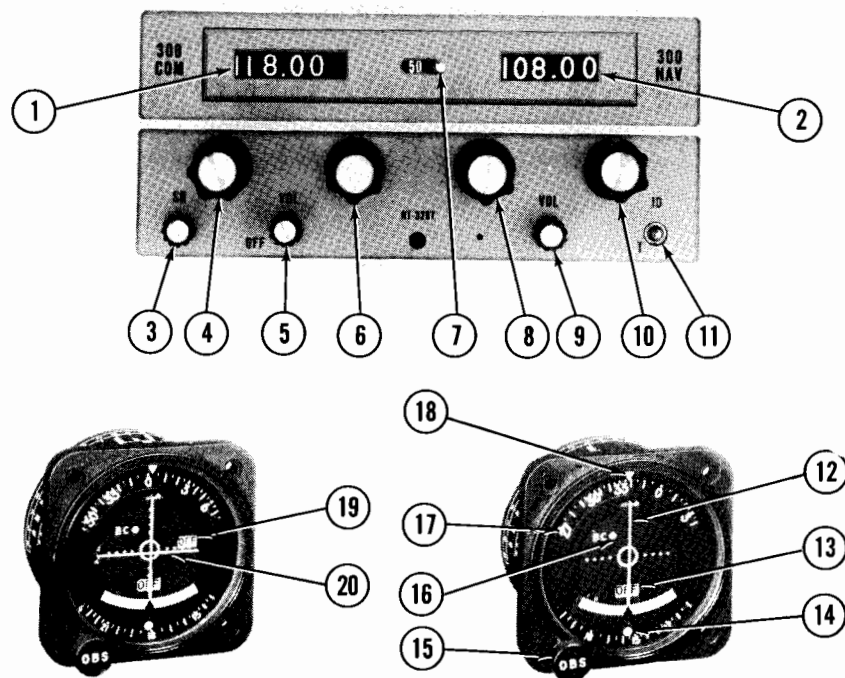

1. RECEIVER-TRANSMITTER FREQUENCY INDICATOR.
2. NAVIGATION RECEIVER FREQUENCY INDICATOR.
3. SQUELCH CONTROL - Used to adjust signal threshold necessary to activate receiver audio. Clockwise rotation increases background noise (decreases squelch action); counterclockwise rotation decreases background noise.
4. COMMUNICATION RECEIVER-TRANSMITTER MEGAHERTZ SELECTOR - Selects communication receiver-transmitter frequency in 1-MHz steps between 118 and 135 MHz.
5. OFF/ON VOLUME CONTROL - Turns set on and controls volume of audio from communications receiver.
6. COMMUNICATION RECEIVER-TRANSMITTER FRACTIONAL MEGAHERTZ SELECTOR - Selects communication receiver-transmitter fractional frequency in .05-MHz steps between .000 and .950 MHz or between .025 and .975 MHz depending on position of 50-25 MHz selector switch.

Figure 1. Cessna 300 Nav/Com (Type RT-328T) (Sheet 1 of 2)

7. 50-25 FRACTIONAL MHz SELECTOR SWITCH - In "50" position, enables communication whole MHz frequency readout to display, and communication fractional MHz control to select fractional part of frequency in .05-MHz steps between .000 and .950 MHz. In "25" position, frequency display and coverage is in .05-MHz steps between .025 and .975.

NOTE

The third-decimal-place digit is not shown on the receiver-transmitter frequency readout.

8. NAVIGATION RECEIVER MEGAHERTZ SELECTOR - Selects navigation receiver frequency in 1-MHz steps between 108 and 117 MHz; simultaneously selects paired glide slope frequency or DME channel.
9. NAVIGATION RECEIVER VOLUME CONTROL - Controls volume of audio from navigation receiver only. Clockwise rotation increases audio level.
10. NAVIGATION RECEIVER FRACTIONAL MEGAHERTZ SELECTOR - Selects navigation receiver frequency in .05-MHz steps between .00 and .95 MHz; simultaneously selects paired glide slope frequency or DME channel.
11. COMBINED IDENTIFIER SIGNAL SELECTOR AND VOR SELF-TEST SELECTOR SWITCH - When VOR station is selected in ID position, station identifier is audible; in center (unmarked) position, identifier is off; in T (momentary on) position, tests VOR navigation circuits.
12. COURSE DEVIATION POINTER - Indicates course deviation from selected omni bearing or localizer centerline.
13. OFF/TO-FROM (OMNI) INDICATOR - Operates only with VOR or localizer signal. "OFF" position (flag) indicates unreliable signal. When "OFF" position disappears, indicator shows whether selected VOR course is "TO" or "FROM" the station (if LOC frequency is selected, indicator will only show "TO").
14. RECIPROCAL COURSE INDEX - Indicates reciprocal of selected VOR course.
15. OMNI BEARING SELECTOR (OBS) - Selects desired course to or from a VOR station.
16. BC - Amber light illuminates when an optional system is installed and the autopilot's back-course button is engaged; indicates CDI needle is reversed on selected receiver when tuned to a localizer frequency (Type IN-514B or IN-525B Indicators Only).
17. BEARING DIAL.
18. COURSE INDEX - Indicates selected VOR course.
19. GLIDE SLOPE "OFF" FLAG - When visible, indicates unreliable glide slope signal or no glide slope signal. The flag disappears when a reliable glide slope signal is being received.
20. GLIDE SLOPE DEVIATION POINTER - Indicates deviation from normal glide slope.

Figure 1. Cessna 300 Nav/Com (Type RT-328T) (Sheet 2 of 2)

## SECTION 2 LIMITATIONS

There is no change to the airplane limitations when this avionic equipment is installed. However, the pilot should be aware that on many Cessna airplanes equipped with the windshield mounted glide slope antenna, pilots should avoid use of 2700 ±100 RPM (or 1800 ±100 RPM with a three bladed propeller) during ILS approaches to avoid propeller interference caused oscillations of the glide slope deviation pointer.

## SECTION 3 EMERGENCY PROCEDURES

There is no change to the airplane emergency procedures when this avionic equipment is installed.

## SECTION 4 NORMAL PROCEDURES

### TO TRANSMIT:

- (1) XMTR SEL Switch -- SELECT transceiver.
- (2) COM Frequency Selector Knobs -- SELECT operating frequency.
- (3) 50-25 Fractional MHz Selector Switch -- SELECT operating frequency.
- (4) OFF/VOL Control -- ON.
- (5) Mike Button -- DEPRESS.

### TO RECEIVE:

- (1) XMTR SEL Switch -- SELECT transceiver.
- (2) SPEAKER/PHONE Switch -- SELECT desired mode.
- (3) COM/NAV Frequency Selector Knobs -- SELECT operating frequency.
- (4) 50-25 Fractional MHz Selector Switch -- SELECT operating frequency (not selected for navigational frequencies).
- (5) VOL Control -- ADJUST to listening level (OFF/VOL knob must be ON).
- (6) SQ Control -- ROTATE counterclockwise to decrease background noise.

### TO OPERATE IDENT FILTER:

- (1) ID-T Switch -- CENTER (unmarked) to include filter in audio circuit of both receivers.
- (2) ID-T Switch -- ID position disconnects filter from audio circuit to hear navigation station identifier (Morse Code) signal.

### NOTE

The ID-T switch should be left in ID position for best communications reception.

### TO SELF TEST VOR NAVIGATION CIRCUITS:

- (1) Tune to usable VOR signal from either a VOR station or a test signal.
- (2) OBS Knob -- ROTATE course index to 0°.
- (3) ID-T Switch -- T position. Vertical pointer should center and OFF-TO-FROM indicator should show FROM.
- (4) ID-T Switch -- T position and rotate OBS knob to displace course index approximately 10° to either side of 0°. Vertical pointer should deflect full scale in direction corresponding to course index displacement.
- (5) ID-T Switch -- CENTER (unmarked) position for normal VOR operation.

### NOTE

This test does not fulfill the requirements of FAR 91.25.

## SECTION 5 PERFORMANCE

There is no change to the airplane performance when this avionic equipment is installed.



# SUPPLEMENT

## CESSNA 300 ADF

(Type R-546E)

### SECTION 1

#### GENERAL

The Cessna 300 ADF is a panel-mounted, digitally tuned automatic direction finder. It is designed to provide continuous 1 kHz digital tuning in the frequency range of 200 kHz to 1,699 kHz and eliminates the need for mechanical band switching. The system is comprised of a receiver, loop antenna, bearing indicator and a sense antenna. In addition, when two or more radios are installed, speaker-phone selector switches are provided. Each control function is described in Figure 1.

The Cessna 300 ADF can be used for position plotting and homing procedures, and for aural reception of amplitude-modulated (AM) signals.

With the function selector knob at ADF, the Cessna ADF provides a visual indication, on the bearing indicator, of the bearing to the transmitting station relative to the nose of the airplane. This is done by combining signals from the sense antenna with signals from the loop antenna.

With the function selector knob at REC, the Cessna ADF uses only the sense antenna and operates as a conventional low-frequency receiver. In the REC, position, the indicator will automatically move to the pointer stow position. This feature alerts the operator to non-ADF operation by positioning and retaining the pointer at the 3:00 o'clock position.

The Cessna 300 ADF is designed to receive transmission from the following radio facilities: commercial broadcast stations, low-frequency range stations, FAA radio beacons, and ILS compass locators.

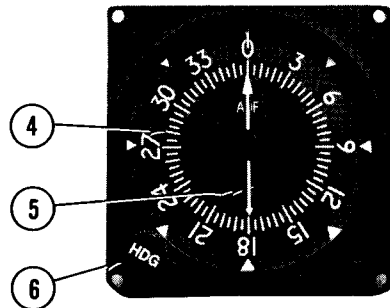
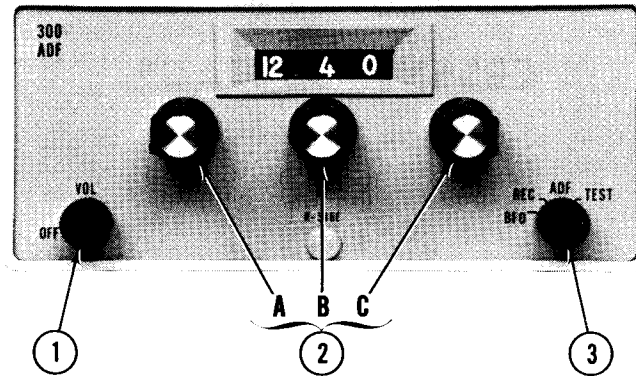

1. OFF/VOL - Controls primary power and audio output level. Clockwise rotation from OFF position applies primary power to receiver; further clockwise rotation increases audio level.
2. FREQUENCY SELECTORS - Knob (A) selects 100-kHz increments of receiver frequency, knob (B) selects 10-kHz increments, and knob (C) selects 1-kHz increments.

Figure 1. Cessna 300 ADF Operating Controls and Indicators (Sheet 1 of 2)

3. FUNCTION

**BFO:** Set operates as communication receiver using only sense antenna and activates 1000-Hz tone beat frequency oscillator to permit coded identifier of stations transmitting keyed CW signals (Morse Code) to be heard.

**REC:** Set operates as standard communication receiver using only sense antenna.

NOTE

In this position an automatic pointer stow feature will alert the pilot to non-ADF operation by positioning and retaining the pointer at the 3:00 o'clock position when the 300 ADF is in the REC function.

**ADF:** Set operates as automatic direction finder using loop and sense antennas.

**TEST:** Momentary-on position used during ADF operation to test bearing reliability. When held in TEST position, slews indicator pointer clockwise; when released, if bearing is reliable, pointer returns to original bearing position.

4. INDEX (ROTATABLE CARD) - Indicates relative, magnetic, or true heading of aircraft.
5. POINTER - Indicates station bearing in degrees of azimuth, relative to the nose of the aircraft. When heading control is adjusted, indicates relative, magnetic, or true bearing from which radio signal is being received.
6. HEADING CONTROL - Rotates card to induce relative, magnetic, or true bearing information.

Figure 1. Cessna 300 ADF Operating Controls and Indicators (Sheet 2 of 2)

## SECTION 2 LIMITATIONS

There is no change to the airplane limitations when this avionic equipment is installed.

## SECTION 3 EMERGENCY PROCEDURES

There is no change to the airplane emergency procedures when this avionic equipment is installed.

## SECTION 4 NORMAL PROCEDURES

### TO OPERATE AS A COMMUNICATIONS RECEIVER ONLY:

- (1) OFF/VOL Control -- ON.
- (2) Function Selector Knob -- REC.

#### NOTE

Indicator's pointer will stow at a 3:00 o'clock position to alert the pilot to non-ADF operation.

- (3) Frequency Selector Knobs -- SELECT operating frequency.
- (4) ADF SPEAKER/PHONE Switch -- SELECT speaker or phone position as desired.
- (5) VOL Control -- ADJUST to desired listening level.

### TO OPERATE AS AN AUTOMATIC DIRECTION FINDER:

- (1) OFF/VOL Control -- ON.
- (2) Frequency Selector Knobs -- SELECT operating frequency.
- (3) ADF SPEAKER/PHONE Switch -- SELECT speaker or phone position.
- (4) Function Selector Knob -- ADF position and note relative bearing on indicator.
- (5) VOL Control -- ADJUST to desired listening level.

#### NOTE

When switching stations place function selector knob in REC position. Then, after station has been selected,

return selector knob to ADF to resume automatic direction finder operation (this practice prevents the bearing indicator from swinging back and forth as frequency dial is rotated).

### TO TEST RELIABILITY OF AUTOMATIC DIRECTION FINDER:

- (1) Function Selector Knob -- ADF position and note relative bearing on indicator.
- (2) Function Selector Knob -- TEST position and observe that pointer moves away from relative bearing at least 10 to 20 degrees.
- (3) Function Selector Knob -- ADF position and observe that pointer returns to same relative bearing as in step (1).

### TO OPERATE BFO:

- (1) OFF/VOL Control -- ON.
- (2) Function Selector Knob -- BFO.
- (3) Frequency Selector Knobs -- SELECT operating frequency.
- (4) ADF SPEAKER/PHONE Switch -- SELECT speaker or phone position.
- (5) VOL Control -- ADJUST to desired listening level.

#### NOTE

A 1000-Hz tone is heard in the audio output when a CW signal (Morse Code) is tuned in properly.

## SECTION 5 PERFORMANCE

There is no change to the airplane performance when this avionic equipment is installed.

**SUPPLEMENT**

**CESSNA 300 TRANSPONDER**  
(Type RT-359A)

**AND**

**OPTIONAL ALTITUDE ENCODER**  
(Type EA-401A)

**SECTION 1**

**GENERAL**

The Cessna 300 Transponder (Type RT-359A), shown in Figure 1, is the airborne component of an Air Traffic Control Radar Beacon System (ATCRBS). The transponder enables the ATC ground controller to "see" and identify the aircraft, while in flight, at distances beyond the primary radar range.

The Cessna 300 Transponder consists of a panel-mounted unit and an externally-mounted antenna. The transponder receives interrogating pulse signals on 1030 MHz and transmits coded pulse-train reply signals on 1090 MHz. It is capable of replying to Mode A (aircraft position identification) and Mode C (altitude information) interrogations on a selective reply basis on any of 4,096 information code selections. When an optional panel-mounted EA-401 altitude encoder (not part of a standard 300 Transponder system) is included in the avionic configuration, the transponder can provide altitude reporting in 100-foot increments between -1000 and +35,000 feet.

All Cessna 300 Transponder operating controls, with the exception of the optional altitude encoder's barometric pressure set knob, are located on the front panel of the unit. The barometric pressure set knob is located on the altitude encoder. Function of the operating controls is described in Figure 1.

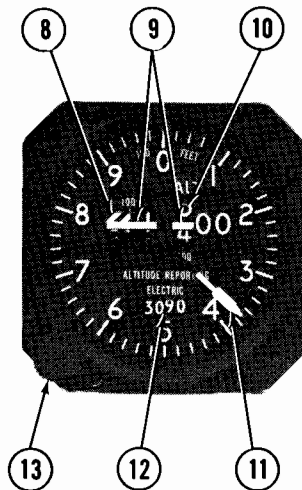
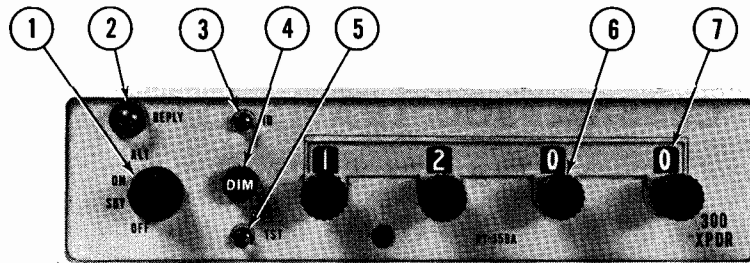

1. **FUNCTION SWITCH** - Controls application of power and selects transponder operating mode, as follows:
  - OFF - Removes power from transponder (turns set off).
  - SBY - Applies power for equipment warm-up.
  - ON - Applies operating power and enables transponder to transmit Mode A reply pulses.
  - ALT - Applies operating power and enables transponder to transmit either Mode A reply pulses or Mode C altitude information pulses selected automatically by the interrogating signal.
2. **REPLY LAMP** - Provides visual indication of transponder replies. During normal operation, lamp flashes when reply pulses are transmitted; when special pulse identifier is

Figure 1. Cessna 300 Transponder (Sheet 1 of 2)

- selected, lamp glows steadily for duration of IDENT pulse transmission. (Reply Lamp will also glow steadily during initial warm-up period.)
3. **IDENT SWITCH** - When depressed, selects special pulse identifier to be transmitted with transponder reply to effect immediate identification of aircraft on ground controller's display. (Reply Lamp will glow steadily during duration of IDENT pulse transmission.)
  4. **DIMMER CONTROL** - Allows pilot to control brilliance of reply lamp.
  5. **SELF-TEST SWITCH** - When depressed, causes transponder to generate a self-interrogating signal to provide a check of transponder operation. (Reply Lamp will illuminate to verify self test operation.)
  6. **REPLY-CODE SELECTOR SWITCHES (4)** - Selects assigned Mode A (or Mode C) reply code.
  7. **REPLY-CODE INDICATORS (4)** - Displays selected Mode A (or Mode C) reply code.
  8. **1000-FOOT DRUM TYPE INDICATOR** - Provides digital altitude readout in 1000-foot increments between -1000 feet and +35,000 feet.
  9. **OFF INDICATOR WARNING FLAG** - Flag appears when power is removed from the system.
  10. **100-FOOT DRUM TYPE INDICATOR** - Provides digital altitude readout in 100-foot increments between 0 feet and 1000 feet.
  11. **20-FOOT INDICATOR NEEDLE** - Indicates altitude in 20-foot increments between 0 feet and 1000 feet.
  12. **BAROMETRIC PRESSURE SET INDICATOR - DRUM TYPE** - Indicates selected barometric pressure in the range of 27.9 to 31.0 inches of mercury.
  13. **BAROMETRIC PRESSURE SET KNOB** - Dials in desired barometric pressure setting in the range of 27.9 to 31.0 inches of mercury.

Figure 1. Cessna 300 Transponder (Sheet 2 of 2)

## SECTION 2 LIMITATIONS

There is no change to the airplane limitations when this avionic equipment is installed.

## SECTION 3 EMERGENCY PROCEDURES

### TO TRANSMIT AN EMERGENCY SIGNAL:

- (1) Function Switch -- ON.
- (2) Reply-Code Selector Switches -- SELECT 7700 operating code.
- (3) ID Switch -- DEPRESS to effect immediate identification of aircraft on ground controller's display.
- (4) DIM Control -- ADJUST light brilliance of reply lamp.

### TO TRANSMIT A SIGNAL REPRESENTING LOSS OF ALL COMMUNICATIONS:

- (1) Function Switch -- ON.
- (2) Reply-Code Selector Switches -- SELECT 7700 operating code for 1 minute, then select 7600 operating code for 15 minutes and then repeat this procedure for remainder of flight.
- (3) ID Switch -- DEPRESS to effect immediate identification of aircraft on ground controller's display.
- (4) DIM Control -- ADJUST light brilliance of reply lamp.

## SECTION 4 NORMAL PROCEDURES

### BEFORE TAKEOFF AND WHILE TAXIING:

- (1) Function Switch -- SBY.

### TO TRANSMIT MODE A (AIRCRAFT POSITION IDENTIFICATION) CODES IN FLIGHT:

- (1) Reply-Code Selector Switches -- SELECT assigned code.

- (2) Function Switch -- ON.
- (3) DIM Control -- ADJUST light brilliance of reply lamp.

### NOTE

During normal operation with function switch in ON position, REPLY lamp flashes indicating transponder replies to interrogations.

- (4) ID Button -- DEPRESS momentarily when instructed by ground controller to "squawk IDENT" (REPLY lamp will glow steadily, indicating IDENT operation).

### TO TRANSMIT MODE C (ALTITUDE INFORMATION) CODES IN FLIGHT:

- (1) Altitude Encoder Barometric Pressure Set Knob -- DIAL assigned barometric pressure.
- (2) Reply-Code Selector Switches -- SELECT assigned code.
- (3) Function Switch -- ALT.

### NOTE

When directed by ground controller to "stop altitude squawk", turn Function Switch to ON for Mode A operation only.

### NOTE

Pressure altitude is transmitted, and conversion to indicated altitude is done in ATC computers. Altitude squawk will agree with indicated altitude when altimeter setting in use by the ground controller is set in the altitude encoder.

- (4) DIM Control -- ADJUST light brilliance of reply lamp.

### TO SELF-TEST TRANSPONDER OPERATION:

- (1) Function Switch -- SBY and wait 30 seconds for equipment to warm-up.
- (2) Function Switch -- ON.
- (3) TST Button -- DEPRESS (Reply lamp should light brightly regardless of DIM control setting).

## SECTION 5 PERFORMANCE

There is no change to the airplane performance when this avionic equipment is installed.

## SUPPLEMENT

### DME (Type 190)

#### SECTION 1 GENERAL

The DME 190 (Distance Measuring Equipment) system consists of a panel mounted 200 channel UHF transmitter-receiver and an externally mounted antenna. The transceiver has a single selector knob that changes the DME's mode of operation to provide the pilot with: distance-to-station, time-to-station, or ground speed readouts. The DME is designed to operate in altitudes up to a maximum of 50,000 feet at ground speeds up to 250 knots and has a maximum slant range of 199.9 nautical miles.

The DME can be channeled independently or by a remote NAV set. When coupled with a remote NAV set, the MHz digits will be covered over by a remote (REM) flag and the DME will utilize the frequency set by the NAV set's channeling knobs. When the DME is not coupled with a remote NAV set, the DME will reflect the channel selected on the DME unit. The transmitter operates in the frequency range of 1041 to 1150 MHz and is paired with 108 to 117.95 MHz to provide automatic DME channeling. The receiver operates in the frequency range of 978 to 1213 MHz and is paired with 108 to 117.95 MHz to provide automatic DME channeling.

All operating controls for the DME are mounted on the front panel of the DME and are described in Figure 1.

#### SECTION 2 LIMITATIONS

There is no change to the airplane limitations when this avionic equipment is installed.

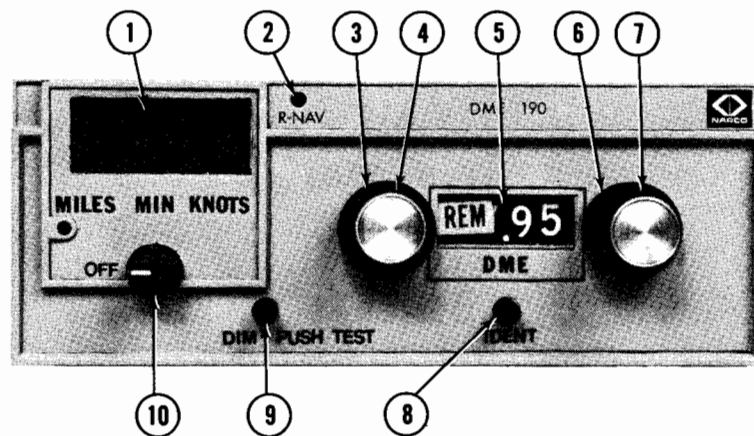

1. **READOUT WINDOW** - Displays function readout in miles (distance-to-station), minutes (time-to-station) or knots (ground speed).
2. **R-NAV INDICATOR LAMP** - The green R-NAV indicator lamp is provided to indicate the DME is coupled to an R-NAV system. Since this DME is not factory installed with an R-NAV system on Cessna airplanes, the R-NAV indicator lamp should never be illuminated. However, if an R-NAV system is coupled to the DME, and when in R-NAV mode, the R-NAV lamp will light which indicates that the distance readout is to the "way point" instead of the DME station. The DME can only give distance (Miles) in R-NAV mode.
3. **REMOTE CHANNELING SELECTOR** - This knob is held stationary by a stop when not coupled to a remote NAV receiver. When coupled to a remote NAV receiver, a stop in the selector is removed and the selector becomes a two position selector. In the first position, the DME will utilize the frequency set by the DME channeling knobs. In the second position, the MHz digits will utilize the frequency set by the NAV unit's channeling knobs.
4. **WHOLE MEGAHERTZ SELECTOR KNOB** - Selects operating frequency in 1-MHz steps between 108 and 117 MHz.
5. **FREQUENCY INDICATOR** - Shows operating frequency selected on the DME or displays remote (REM) flag to indicate DME is operating on a frequency selected by a remote NAV receiver.

Figure 1. DME 190 Operating Controls (Sheet 1 of 2)

6. **FRACTIONAL MEGAHERTZ SELECTOR KNOB** - Selects operating frequency in 50 kHz steps. This knob has two positions, one for the 0 and one for the 5.
7. **FRACTIONAL MEGAHERTZ SELECTOR KNOB** - Selects operating frequency in tenths of a Megahertz (0-9).
8. **IDENT KNOB** - Rotation of this control increases or decreases the volume of the received station's Ident signal. An erratic display, accompanied by the presence of two Ident signals, can result if the airplane is flying in an area where two stations, using the same frequency, are transmitting.
9. **DIM/PUSH TEST KNOB** -  
**DIM:** Controls the brilliance of the readout lamp's segments. Rotate the control as desired for proper lamp illumination in the function window (The frequency window is dimmed by the aircraft's radio light dimming control).  
**PUSH TEST:** This control is used to test the illumination of the readout lamps, with or without being tuned to a station. Press the control, a readout of 188 8 should be seen with the mode selector switch in the MIN or KNOTS position. The decimal point along with 188.8 will light in the MILES mode. When the control is released, and had the DME been channeled to a nearby station, the distance to that station will appear. If the station channeled was not in range, a "bar" readout will be seen (--. - or -- -).
10. **MODE SELECTOR SWITCH** -  
**OFF:** Turns the DME OFF.  
**MILES:** Allows a digital readout to appear in the window which represents slant range (in nautical miles) to or from the channeled station.  
**MIN:** Allows a digital readout (in minutes) to appear in the window that it will take the airplane to travel the distance to the channeled station. This time is only accurate when flying directly TO the station and after the ground speed has stabilized.  
**KNOTS:** Allows a digital readout (in knots) to appear in the window that is ground speed and is valid only after the stabilization time (approximately 2 minutes) has elapsed when flying directly TO or FROM the channeled station.

Figure 1. DME 190 Operating Controls (Sheet 2 of 2)



### SECTION 3 EMERGENCY PROCEDURES

There is no change to the airplane emergency procedures when this avionic equipment is installed.

### SECTION 4 NORMAL PROCEDURES

TO OPERATE:

- (1) Mode Selector Switch -- SELECT DME function.
- (2) Frequency Selector Knobs -- SELECT desired operating frequency and allow equipment to warm-up at least 2 minutes.

#### NOTE

If frequency is set on remote NAV receiver, place remote channeling selector in the REM position.

- (3) PUSH TEST Control -- PUSH and observe reading of 188.8 in function window.
- (4) DIM Control -- ADJUST.
- (5) IDENT Control -- ADJUST audio output in speaker.
- (6) Mode Selector Functions:
  - MILES Position -- Distance-to-Station is slant range in nautical miles.
  - MIN Position -- Time-to-Station when flying directly to station.
  - KNOTS Position -- Ground Speed in knots when flying directly to or from station.

#### CAUTION

After the DME 190 has been turned OFF, do not turn it on again for 5 seconds to allow the protective circuits to reset.

### SECTION 5 PERFORMANCE

There is no change to the airplane performance when this avionic equipment is installed.

## SUPPLEMENT HF TRANSCEIVER (Type PT10-A)

### SECTION 1 GENERAL

The PT10-A HF Transceiver, shown in Figure 1, is a 10-channel AM transmitter-receiver which operates in the frequency range of 2.0 to 18.0 Megahertz. The transceiver is automatically tuned to the operating frequency by a Channel Selector. The operating controls for the unit are mounted on the front panel of the transceiver. The system consists of a transceiver, antenna load box, fixed wire antenna and associated wiring.

The Channel Selector Knob determines the operating frequency of the transmitter and receiver. The frequencies of operation are shown on the frequency chart adjacent to the channel selector.

The VOLUME control incorporates the power switch for the transceiver. Clockwise rotation of the volume control turns the set on and increases the volume of audio.

The meter on the face of the transceiver indicates transmitter output.

The system utilizes the airplane microphone, headphone and speaker. When two or more radios are installed, a transmitter selector switch and a speaker-phone switch are provided.

### SECTION 2 LIMITATIONS

There is no change to the airplane limitations when this avionic equipment is installed.

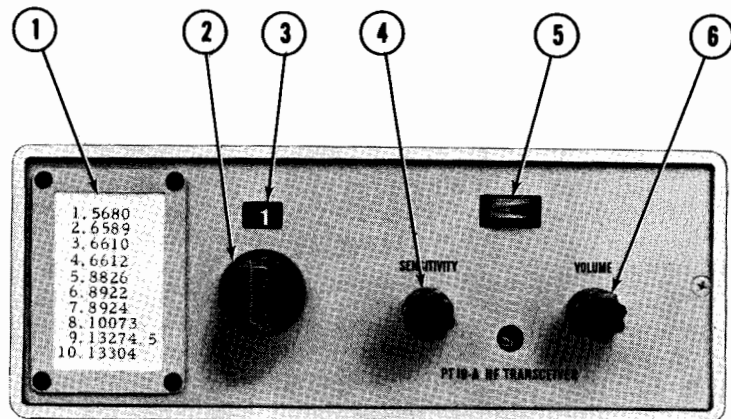

1. **FREQUENCY CHART** - Shows the frequency of the channel in use (frequencies shown may vary and are shown for reference purposes only).
2. **CHANNEL SELECTOR** - Selects channels 1 thru 10 as listed in the frequency chart.
3. **CHANNEL READOUT WINDOW** - Displays channel selected in frequency chart.
4. **SENSITIVITY CONTROL** - Controls the receiver sensitivity for audio gain.
5. **ANTENNA TUNING METER** - Indicates the energy flowing from the transmitter into the antenna. The optimum power transfer is indicated by the maximum meter reading.
6. **ON/OFF VOLUME CONTROL** - Turns complete set on and controls volume of audio.

Figure 1. HF Transceiver (Type PT10-A)

### SECTION 3 EMERGENCY PROCEDURES

There is no change to the airplane emergency procedures when this avionic equipment is installed.

### SECTION 4 NORMAL PROCEDURES

#### TO OPERATE:

- (1) XMTR SEL Switch -- SELECT transceiver.
- (2) SPEAKER/PHONE Switch -- SELECT desired mode.
- (3) VOLUME Control -- ON (allow equipment to warm up and adjust audio to comfortable listening level).
- (4) Frequency Chart -- SELECT desired operating frequency.
- (5) Channel Selector -- DIAL in frequency selected in step 4.
- (6) SENSITIVITY Control -- ROTATE clockwise to maximum position.

#### NOTE

If receiver becomes overloaded by very strong signals, back off SENSITIVITY control until background noise is barely audible.

#### NOTE

The antenna tuning meter indicates the energy flowing from the airplane's transmitter into the antenna. The optimum power transfer is indicated by the maximum meter reading.

- (7) To Transmit -- DEPRESS microphone switch button and speak directly into microphone.
- (8) To Receive -- RELEASE microphone switch button.

### SECTION 5 PERFORMANCE

There is no change to the airplane performance when this avionic equipment is installed.

## SUPPLEMENT

# SSB HF TRANSCEIVER

(Type ASB-125)

### SECTION 1

#### GENERAL

The ASB-125 HF transceiver is an airborne, 10-channel, single sideband (SSB) radio with a compatible amplitude modulated (AM) transmitting-receiving system for long range voice communications in the 2 to 18 MHz frequency range. The system consists of a panel mounted receiver/exciter, a remote mounted power amplifier/power supply, an antenna coupler and an externally mounted, fixed wire, medium/high frequency antenna.

A channel selector knob determines the operating frequency of the transceiver which has predetermined crystals installed to provide the desired operating frequencies. A mode selector control is provided to supply the type of emission required for the channel, either sideband, AM or telephone for public correspondence. An audio knob, clarifier knob and squelch knob are provided to assist in audio operation during receive. In addition to the aforementioned controls, which are all located on the receiver/exciter, a meter is incorporated to provide antenna loading readouts.

The system utilizes the airplane microphone, headphone and speaker. When two or more radios are installed, a transmitter selector switch and a speaker-phone switch are provided.

### SECTION 2

#### LIMITATIONS

There is no change to the airplane limitations when this avionic equipment is installed. However, the pilot should be aware of the two following radio limitations:

- (1) For sideband operation in the United States, Canada and various

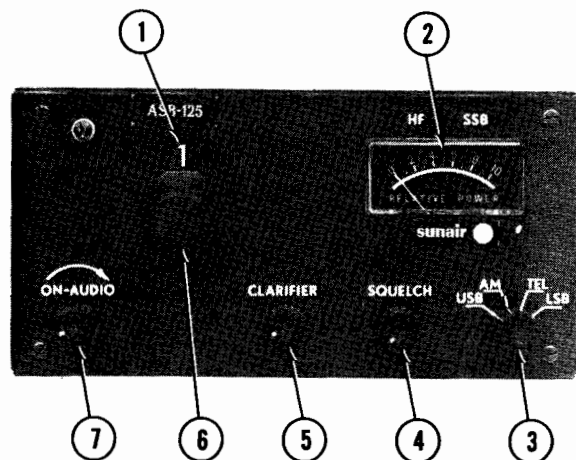

1. CHANNEL WINDOW - Displays selected operating channel.
2. RELATIVE POWER METER - Indicates relative radiated power of the power amplifier/antenna system.
3. MODE SELECTOR CONTROL - Selects one of the desired operating modes:
  - USB - Selects upper side band operation for long range voice communications.
  - AM - Selects compatible AM operation and full AM reception.
  - TEL - Selects upper sideband with reduced carrier, used for public correspondence telephone and ship-to-shore.
  - LSB - (Optional) Selects lower sideband operation (not legal in U. S., Canada and most other countries).
4. SQUELCH CONTROL - Used to adjust signal threshold necessary to activate receiver audio. Clockwise rotation increases background noise (decreases squelch action); counterclockwise rotation decreases background noise.
5. CLARIFIER CONTROL - Used to "clarify" single sideband speech during receive while in USB mode only.
6. CHANNEL SELECTOR CONTROL - Selects desired channel. Also selects AM mode if channel frequency is 2003 kHz, 2182 kHz or 2638 kHz.
7. ON - AUDIO CONTROL - Turns set ON and controls receiver audio gain.

Figure 1. SSB HF Transceiver Operating Controls

other countries, only the upper sideband may be used. Use of lower side band is prohibited.

- (2) Only AM transmissions are permitted on frequencies 2003 kHz, 2182 kHz, and 2638 kHz. The selection of these channels will automatically select the AM mode of transmission.

## SECTION 3 EMERGENCY PROCEDURES

There is no change to the airplane emergency procedures when this avionic equipment is installed.

## SECTION 4 NORMAL PROCEDURES

### TO OPERATE:

- (1) XMTR SEL Switch -- SELECT transceiver.
- (2) SPEAKER/PHONE Switch -- SELECT.
- (3) ON-AUDIO Control -- ON (allow equipment to warm up for 5 minutes for sideband or one minute for AM operation and adjust audio to comfortable listening level).
- (4) Channel Selector Control -- SELECT desired operating frequency.
- (5) Mode Selector Control -- SELECT operating mode.
- (6) Squelch Control -- ADJUST the audio gain counterclockwise for normal noise output, then slowly adjust clockwise until the receiver is silent.
- (7) Clarifier Control -- ADJUST when upper single sideband RF signal is being received for maximum clarity.
- (8) Mike Button -- DEPRESS to transmit voice communications.

### NOTE

Voice communications are not available in the LSB mode.

### NOTE

Lower sideband (LSB) mode is not legal in the U. S., Canada, and most other countries.

## SECTION 5 PERFORMANCE

There is no change to the airplane performance when this avionic equipment is installed.

## SUPPLEMENT

# CESSNA 400 MARKER BEACON

(Type R-402A)

### SECTION 1 GENERAL

The system consists of a 75 MHz marker beacon receiver, three indicator lights, one speaker/phone switch, a light dimming control, an ON/OFF/VOLUME control, and a 75 MHz marker beacon antenna. In addition, on 150, 182, 206, 207, 210 and 337 series models, a HI-LO sensitivity selector switch and a press-to-test button are provided. On all 172, 177, 177RG, 180 and 185 series models, a single, three position switch is provided for HI-LO sensitivity selection or test selection.

This system provides visual and aural indications of 75 MHz ILS marker beacon signals as the marker is passed. The following table lists the three most currently used marker facilities and their characteristics.

### MARKER FACILITIES

MARKER	IDENTIFYING TONE	LIGHT*
Inner	Continuous 6 dots/sec (3000 Hz)	White
Middle	Alternate dots and dashes (1300 Hz)	Amber
Outer	2 dashes/sec (400 Hz)	Blue

\* When the identifying tone is keyed, the respective indicating light will blink accordingly.

Operating controls and indicator lights are shown and described in Figure 1.

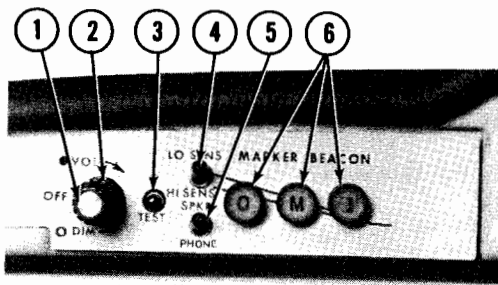

TYPICAL INSTALLATION  
ON ALL 150 MODEL SERIES

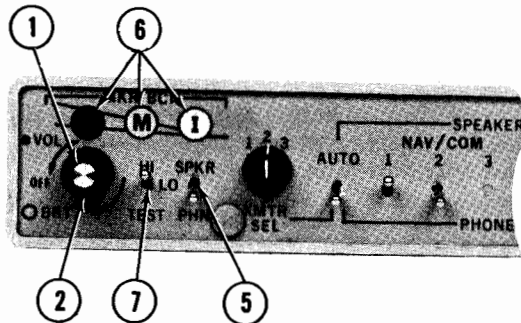

TYPICAL INSTALLATION  
ON ALL 172, 177, 177RG,  
180 & 185 MODEL SERIES

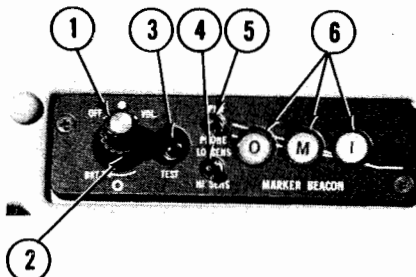

TYPICAL INSTALLATION  
ON ALL 337 MODEL SERIES

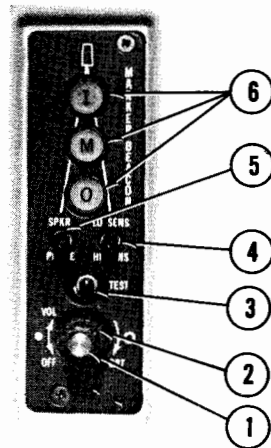

TYPICAL INSTALLATION  
ON ALL 182, 206, 207  
& 210 MODEL SERIES

Figure 1. Cessna 400 Marker Beacon Operating Controls and Indicator Lights (Sheet 1 of 2)

1. OFF/VOLUME CONTROL - The small, inner control turns the set on or off and adjusts the audio listening level. Clockwise rotation turns the set on and increases the audio level.
2. DIM/BRT CONTROL - The large, outer control provides light dimming for the marker lights. Clockwise rotation increases light intensity.
3. TEST SWITCH - (150, 182, 206, 207, 210 & 337 Model Series Only) When the press-to-test switch button is depressed, the marker beacon lights will illuminate, indicating the lights are operational (the test position is a lamp test function only).

NOTE

Turn the set on, and rotate the DIM control clockwise (fully on) in order to view the marker beacon lights during test.

4. LO/HI SENS SWITCH - (150, 182, 206, 207, 210 & 337 Model Series Only) In the LO position (Up), receiver sensitivity is positioned for ILS approaches. In the HI position (Down), receiver sensitivity is positioned for airway flying.
5. SPEAKER/PHONE SWITCH - Selects speaker or phone for aural reception.
6. MARKER BEACON INDICATOR LIGHTS - Indicates passage of outer, middle and inner marker beacons. The OUTER light is blue, the MIDDLE light is amber and the INNER light is white.
7. HI/LO/TEST SWITCH - (172, 177, 177RG, 180 & 185 Model Series Only) In the HI position (Up), receiver sensitivity is positioned for airway flying. In the LO position (Center), receiver sensitivity is positioned for ILS approaches. In the TEST position (Down), the marker lights will illuminate, indicating the lights are operational (the test position is a lamp test function only).

NOTE

Turn the set on, and rotate the BRIGHT control clockwise (fully on) in order to view the marker beacon lights during test. The TEST position on the switch is spring loaded to return the switch to the LO SENS position when TEST position is released.

Figure 1. Cessna 400 Marker Beacon Operating Controls and Indicator Lights (Sheet 2 of 2)

## SECTION 2 LIMITATIONS

There is no change to the airplane limitations when this avionic equipment is installed.

## SECTION 3 EMERGENCY PROCEDURES

There is no change to the airplane emergency procedures when this avionic equipment is installed.

## SECTION 4 NORMAL PROCEDURES

### TO OPERATE:

- (1) OFF/VOL Control -- VOL position and adjust to desired listening level.
- (2) LO/HI SENS Switch -- SELECT HI position for airway flying or LO position for ILS approaches.
- (3) SPKR/PHONE Switch -- SELECT speaker or phone audio.
- (4) TEST Switch -- PRESS and ensure that marker beacon indicator lights are operative.

### NOTE

Ensure that BRT control is on enough to view the marker beacon.

## SECTION 5 PERFORMANCE

There is no change to the airplane performance when this avionic equipment is installed.

## SUPPLEMENT

# CESSNA NAVOMATIC 200A AUTOPILOT (Type AF-295B)

## SECTION 1 GENERAL

The Cessna 200A Navomatic is an all electric, single-axis (aileron control) autopilot system that provides added lateral and directional stability. Components are a computer-amplifier, a turn coordinator, an aileron actuator, and a course deviation indicator(s) incorporating a localizer reversed (BC) indicator light.

Roll and yaw motions of the airplane are sensed by the turn coordinator gyro. The computer-amplifier electronically computes the necessary correction and signals the actuator to move the ailerons to maintain the airplane in the commanded lateral attitude.

The 200A Navomatic will also capture and track a VOR or localizer course using signals from a VHF navigation receiver.

The operating controls for the Cessna 200A Navomatic are located on the front panel of the computer-amplifier, shown in Figure 1. The primary function pushbuttons (DIR HOLD, NAV CAPT, and NAV TRK), are interlocked so that only one function can be selected at a time. The HI SENS and BACK CRS pushbuttons are not interlocked so that either or both of these functions can be selected at any time.

## SECTION 2 LIMITATIONS

There is no change to the airplane limitations when this avionic equipment is installed. However, the following autopilot limitations should be adhered to during airplane operation:

### BEFORE TAKE-OFF AND LANDING:

- (1) A/P ON-OFF Switch -- OFF.

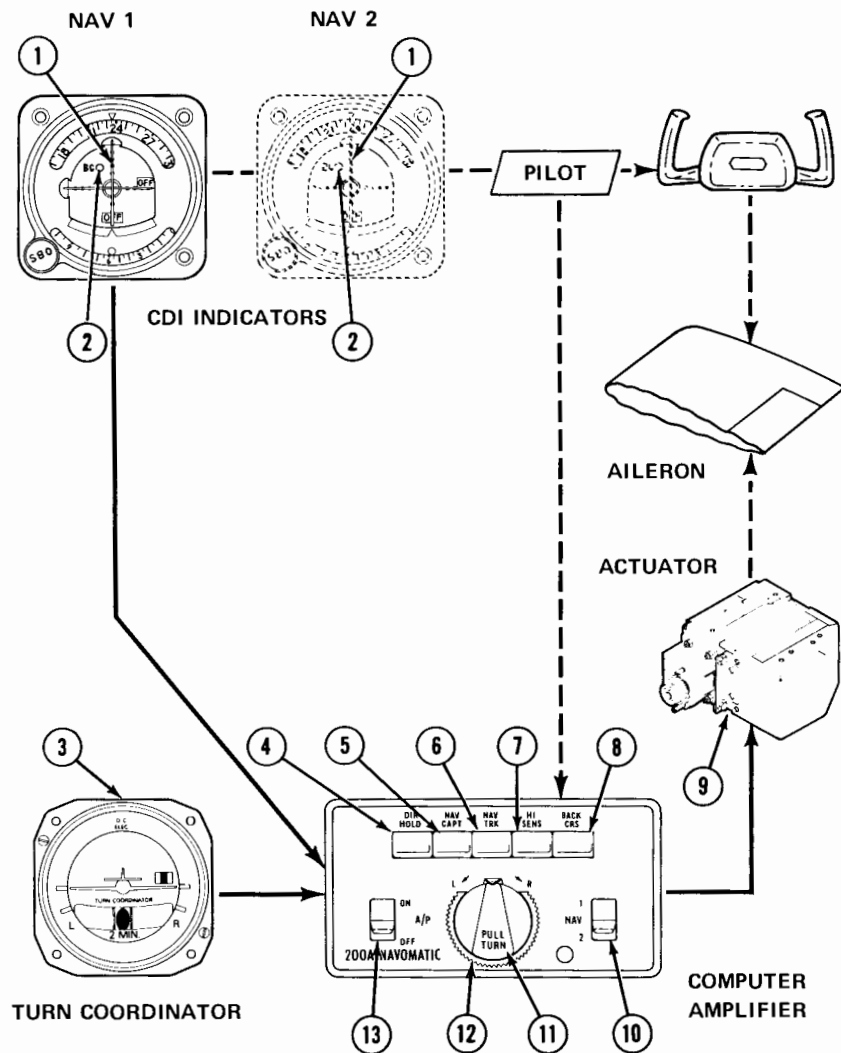

1. COURSE DEVIATION INDICATOR - Provides VOR/LOC navigation inputs to autopilot for intercept and tracking modes.
2. LOCALIZER REVERSED INDICATOR LIGHT - Amber light, labeled BC, illuminates when BACK CRS button is pushed in (engaged) and LOC frequency selected. BC light indicates course indicator needle is reversed on selected receiver (when tuned to a localizer frequency). This light is located within the CDI indicator.
3. TURN COORDINATOR - Senses roll and yaw for wings leveling and command turn functions.
4. DIR HOLD - Airplane holds direction it is flying at time button is pushed.
5. NAV CAPT - Airplane will turn to and capture selected VOR or LOC course.
6. NAV TRK - Airplane tracks selected VOR or LOC course.
7. HI SENS - During NAV CAPT or NAV TRK operation, this high sensitivity setting increases autopilot response to NAV signal to provide more precise operation during localizer approach. In low sensitivity position (pushbutton out), response to NAV signal is dampened for smoother tracking of enroute VOR radials; it also smooths out effect of course scalloping during NAV operation.
8. BACK CRS - Used with LOC operation only. With A/P switch OFF or ON, and when navigation receiver selected by NAV switch is set to a localizer frequency, it reverses normal localizer needle indication (CDI) and causes localizer reversed (BC) light to illuminate. With A/P switch ON, reverses localizer signal to autopilot.
9. ACTUATOR - The torque motor in the actuator causes the ailerons to move in the desired direction.
10. NAV - Selects NAV 1 or NAV 2 navigation receiver.
11. PULL TURN - When pulled out and centered in detent, airplane will fly wings-level; when turned to the right (R), the airplane will execute a right, standard rate turn; when turned to the left (L), the airplane will execute a left, standard rate turn. When centered in detent and pushed in, the operating mode selected by a push button is engaged.
12. TRIM - Used to trim autopilot to compensate for minor variations in aircraft trim or weight distribution. (For proper operation, the aircraft's rudder trim must be manually trimmed before the autopilot is engaged.)
13. A/P - Turns autopilot ON or OFF.

Figure 1. Cessna 200A Autopilot, Operating Controls and Indicators  
(Sheet 1 of 2)

Figure 1. Cessna 200A Autopilot, Operating Controls and Indicators  
(Sheet 2 of 2)



- (2) BACK CRS Button -- DISENGAGED (OUT). (Refer to Section 4 of this supplement and see Step 6 and Caution note under "NAV CAPTURE (VOR/LOC)".)

NAV CAPTURE (VOR/LOC):

- (1) Fly a manual intercept procedure if more than 15 miles from the station or more than 3 minutes from intercept.

### SECTION 3 EMERGENCY PROCEDURES

TO OVERRIDE THE AUTOPILOT:

- (1) Airplane control Wheel -- ROTATE as required to override autopilot.

NOTE

The servo may be overpowered at anytime without damage.

TO TURN OFF AUTOPILOT:

- (1) A/P ON-OFF Switch -- OFF.

### SECTION 4 NORMAL PROCEDURES

BEFORE TAKE-OFF AND LANDING:

- (1) A/P ON-OFF Switch -- OFF.  
(2) BACK CRS Button -- OFF (see Caution note under Nav Capture).

NOTE

Periodically verify operation of amber warning light(s), labeled BC on CDI(s), by engaging BACK CRS button with a LOC frequency selected.

INFLIGHT WINGS LEVELING:

- (1) Airplane Trim -- ADJUST.  
(2) PULL-TURN Knob -- PULL out and center in detent.  
(3) A/P ON-OFF Switch -- ON.  
(4) Autopilot TRIM Control -- ADJUST for zero turn rate.

COMMAND TURNS:

- (1) PULL-TURN Knob -- PULL and ROTATE.

DIRECTION HOLD:

- (1) PULL-TURN Knob -- PULL out and center in detent.  
(2) DIR HOLD Button -- PUSH.  
(3) PULL-TURN Knob -- PUSH in detent position.  
(4) Autopilot TRIM Control -- READJUST to minimize heading drift.

NAV CAPTURE (VOR/LOC):

- (1) PULL-TURN Knob -- PULL out.  
(2) NAV 1-2 Selector Switch -- SELECT desired VOR receiver.  
(3) Nav Receiver OBS -- SET VOR course (if tracking omni).  
(4) NAV CAPT Button -- PUSH.  
(5) HI SENS Button -- PUSH.  
(6) BACK CRS Button -- PUSH only if intercepting localizer front course outbound or back course inbound.

**CAUTION**

With BACK CRS button pushed in and localizer frequency selected, the CDI on selected nav radio will be reversed even when the autopilot switch is OFF.

- (7) PULL-TURN Knob -- TURN airplane parallel to course. Then PUSH for automatic intercept. If more than 15 miles from the station or more than 3 minutes from intercept, use a manual intercept procedure.  
(8) NAV TRK Button -- PUSH when CDI centers and airplane is within  $\pm 5^\circ$  of course heading.  
(9) HI SENS Button -- DISENGAGE for omni tracking (leave ENGAGED for localizer).

NAV TRACKING (VOR/LOC):

- (1) PULL-TURN Knob -- PULL out.

- (2) NAV 1-2 Selector Switch -- SELECT desired VOR receiver.
- (3) Nav Receiver OBS -- SET VOR course (if tracking omni).
- (4) NAV TRK Button -- PUSH.
- (5) HI SENS Button -- PUSH for localizer; disengage for omni.
- (6) BACK CRS Button -- PUSH only if tracking localizer front course outbound or back course inbound.

**CAUTION**

See caution paragraph under Nav Capture.

- (7) PULL-TURN Knob -- PUSH when airplane is on course and on heading.
- (8) Autopilot TRIM Control -- READJUST as required to maintain track.

## SECTION 5 PERFORMANCE

There is no change to the airplane performance when this avionic equipment is installed.

## SUPPLEMENT

# CESSNA NAVOMATIC 300A AUTOPILOT (Type AF-395A)

## SECTION 1 GENERAL

The Cessna 300A Navomatic is an all electric, single-axis (aileron control) autopilot system that provides added lateral and directional stability. Components are a computer-amplifier, a turn coordinator, a directional gyro, an aileron actuator and a course deviation indicator(s) incorporating a localized reversed (BC) indicator light.

Roll and yaw motions of the airplane are sensed by the turn coordinator gyro. Deviations from the selected heading are sensed by the directional gyro. The computer-amplifier electronically computes the necessary correction and signals the actuator to move the ailerons to maintain the airplane in the commanded lateral attitude or heading.

The 300A Navomatic will also intercept and track a VOR or localizer course using signals from a VHF navigation receiver.

The operating controls for the Cessna 300A Navomatic are located on the front panel of the computer-amplifier and on the directional gyro, shown in Figure 1. The primary function pushbuttons (HDG SEL, NAV INT, and NAV TRK), are interlocked so that only one function can be selected at a time. The HI SENS and BACK CRS pushbuttons are not interlocked so that either or both of these functions can be selected at any time.

## SECTION 2 LIMITATIONS

There is no change to the airplane limitations when this avionic equip-

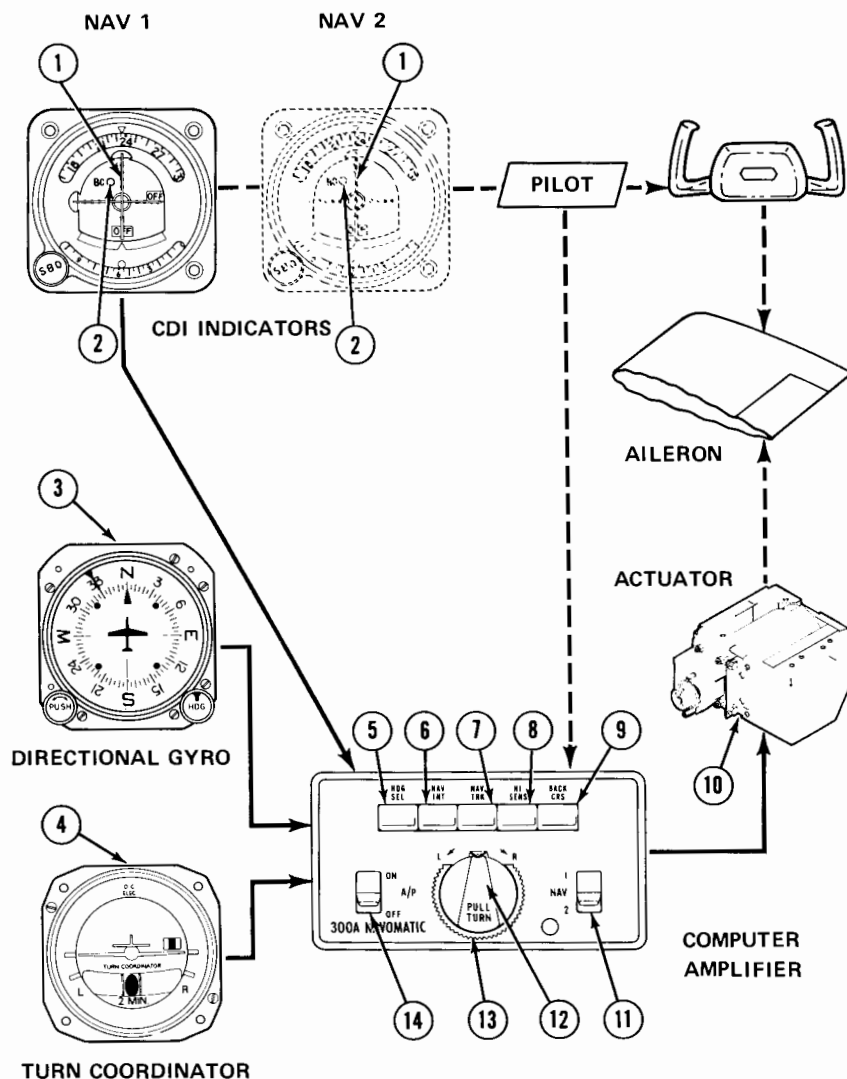

Figure 1. Cessna 300A Autopilot, Operating Controls and Indicators  
(Sheet 1 of 2)

1. COURSE DEVIATION INDICATOR - Provides VOR/LOC navigation inputs to autopilot for intercept and tracking modes.
2. LOCALIZER REVERSED INDICATOR LIGHT - Amber light, labeled BC, illuminates when BACK CRS button is pushed in (engaged) and LOC frequency selected. BC light indicates course indicator needle is reversed on selected receiver (when tuned to a localizer frequency). This light is located within the CDI indicator.
3. DIRECTIONAL GYRO INDICATOR - Provides heading information to the autopilot for heading intercept and hold.
4. TURN COORDINATOR - Senses roll and yaw for wings leveling and command turn functions.
5. HDG SEL - Aircraft will turn to and hold heading selected by the heading "bug" on the directional gyro.
6. NAV INT - When heading "bug" on DG is set to selected course, aircraft will turn to and intercept selected VOR or LOC course.
7. NAV TRK - When heading "bug" on DG is set to selected course, aircraft will track selected VOR or LOC course.
8. HI SENS - During NAV INT or NAV TRK operation, this high sensitivity setting increases autopilot response to NAV signal to provide more precise operation during localizer approach. In low-sensitivity position (pushbutton out), response to NAV signal is dampened for smoother tracking of enroute VOR radials; it also smooths out effect of course scalloping during NAV operation.
9. BACK CRS - Used with LOC operation only. With A/P switch OFF or ON, and when navigation receiver selected by NAV switch is set to a localizer frequency, it reverses normal localizer needle indication (CDI) and causes localizer reversed (BC) light to illuminate. With A/P switch ON, reverses localizer signal to autopilot.
10. ACTUATOR - The torque motor in the actuator causes the ailerons to move in the desired direction.
11. NAV - Selects NAV 1 or NAV 2 navigation receiver.
12. PULL TURN - When pulled out and centered in detent, airplane will fly wings-level; when turned to the right (R), the airplane will execute a right, standard rate turn; when turned to the left (L), the airplane will execute a left, standard rate turn. When centered in detent and pushed in, the operating mode selected by a push button is engaged.
13. TRIM - Used to trim autopilot to compensate for minor variations in aircraft trim or lateral weight distribution. (For proper operation, the aircraft's rudder trim must be manually trimmed before the autopilot is engaged.)
14. A/P - Controls primary power to autopilot servo (turns autopilot ON or OFF).

Figure 1. Cessna 300A Autopilot, Operating Controls and Indicators  
(Sheet 2 of 2)

ment is installed. However, the following autopilot limitations should be adhered to during airplane operation:

**BEFORE TAKE-OFF AND LANDING:**

- (1) A/P ON-OFF Switch -- OFF.
- (2) BACK CRS Button -- DISENGAGED (OUT). (Refer to Section 4 of this supplement and see Step 8 and Caution note under "NAV INTERCEPT (VOR/LOC)".)

### SECTION 3 EMERGENCY PROCEDURES

**TO OVERRIDE THE AUTOPILOT:**

- (1) Airplane Control Wheel -- ROTATE as required to override autopilot.

**NOTE**

The servo may be overpowered at any time without damage.

**TO TURN OFF AUTOPILOT:**

- (1) A/P ON-OFF Switch -- OFF.

### SECTION 4 NORMAL PROCEDURES

**BEFORE TAKE-OFF AND LANDING:**

- (1) A/P ON-OFF Switch -- OFF.
- (2) BACK CRS Button -- OFF (see caution note under Nav Intercept).

**NOTE**

Periodically verify operation of amber warning light(s), labeled BC on CDI(s), by engaging BACK CRS button with a LOC frequency selected.

**INFLIGHT WINGS LEVELING:**

- (1) Airplane Trim -- ADJUST.

- (2) PULL-TURN Knob -- PULL out and center in detent.
- (3) A/P ON-OFF Switch -- ON.
- (4) Autopilot TRIM Control -- ADJUST for zero turn rate.

**HEADING SELECT:**

- (1) Directional Gyro -- SET to airplane magnetic heading.
- (2) Heading Selector Knob -- ROTATE bug to desired heading.
- (3) Heading Select Button -- PUSH.
- (4) PULL-TURN Knob -- PUSH.

**NOTE**

Airplane will return automatically to selected heading. If airplane fails to hold the precise heading, readjust autopilot lateral TRIM knob as required or disengage autopilot and reset manual trim.

**NAV INTERCEPT (VOR/LOC):**

- (1) PULL-TURN Knob -- PULL out.
- (2) NAV 1-2 Selector Switch -- SELECT.
- (3) Nav Receiver OBS -- SET VOR course (if tracking omni).
- (4) Heading Selector Knob -- ROTATE bug to selected course (VOR or localizer).
- (5) Directional Gyro -- SET for magnetic heading.
- (6) NAV INT Button -- PUSH.
- (7) HI SENS Button -- PUSH for localizer and "close-in" omni intercepts.
- (8) BACK CRS Button -- PUSH only if intercepting localizer front course outbound or back course inbound.

**CAUTION**

With BACK CRS button pushed in and localizer frequency selected, the CDI on selected nav radio will be reversed even when the autopilot switch is OFF.

- (9) PULL-TURN Knob -- PUSH.

**NOTE**

Airplane will automatically turn to a 45° intercept angle.

- (10) NAV TRK Button -- PUSH when CDI centers (within one dot) and airplane is within ±10° of course heading.

- (11) HI SENS Button -- Disengage for omni tracking (leave engaged for localizer).

NAV TRACKING (VOR/LOC):

- (1) PULL-TURN Knob -- PULL out.
- (2) NAV 1-2 Selector Switch -- SELECT desired VOR receiver.
- (3) Nav Receiver OBS -- SET VOR course (if tracking omni).
- (4) Heading Selector Knob -- ROTATE bug to selected course (VOR or localizer).
- (5) Directional Gyro -- SET for magnetic heading.
- (6) NAV TRK Button -- PUSH.
- (7) HI SENS Button -- PUSH for localizer; disengage for omni.
- (8) BACK CRS Button -- PUSH only if tracking localizer front course outbound or back course inbound.

**CAUTION**

See caution paragraph under Nav Intercept.

- (9) PULL-TURN Knob -- PUSH when CDI is within 1 dot and airplane is within  $\pm 10^\circ$  of course heading.

NOTE

If CDI remains steadily off center, readjust autopilot lateral trim control as required.

## SECTION 5 PERFORMANCE

There is no change to the airplane performance when this avionic equipment is installed.

Notes